

**PRED MONTÁŽOU SI POZORNE PREČÍTAJTE
TENTO MONTÁŽNY NÁVOD**

KESA 3 – L

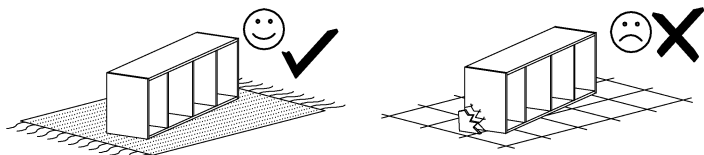

NÁBYTOK MONTUJTE NA MÄKKOM POVRCHU

**DREVENÉ KOMPONENTY A ČASTI NÁBYTKU S
LAMINOVANOU DOSKOU ČISTITE IBA MÄKKOU
HANDRIČKOU
CHRÁŇTE PRED VLHKOSŤOU**

**NÄSTROJE NA MONTÄŽ
NIE SÜ SÜČASŤOU DODÄVKY**

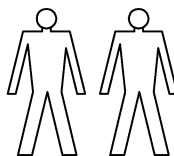
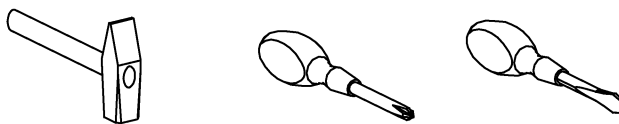

**V PRÍPADE PROBLÉMU ČI CHÝBAJÚCEJ
SÜČIASŤKY PROSÍM UVEĎTE V REKLAMAČNOM
PROTOKOLE SÉRIOVÉ ČÍSLO BALÍKU V KTOROM
SA SÜČIASŤKA MALA NACHÄDZAŤ/NACHÄDZALA**

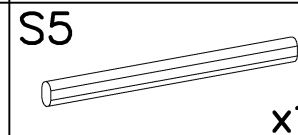
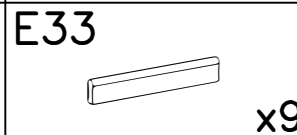
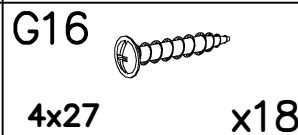
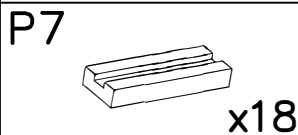
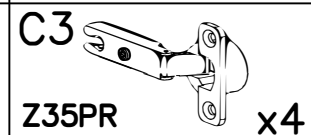
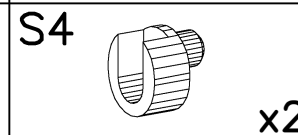
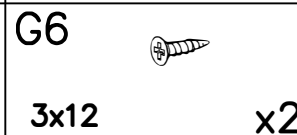
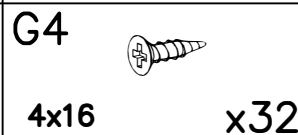
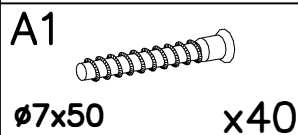
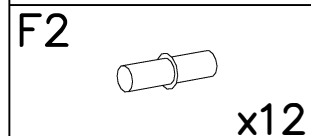
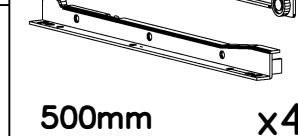
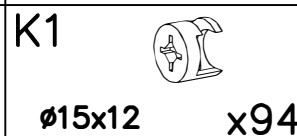
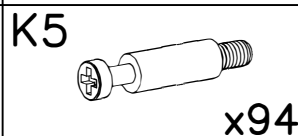
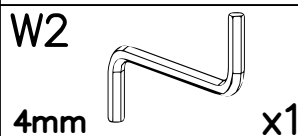
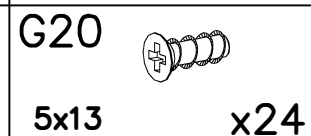
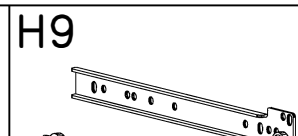
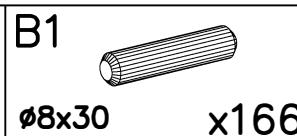
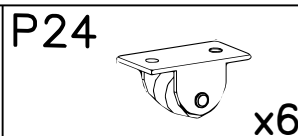
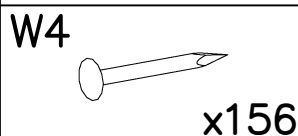
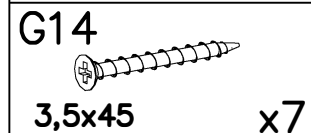
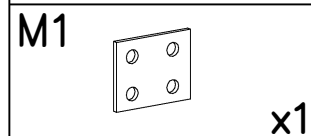
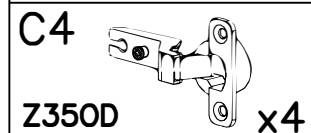
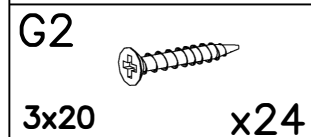
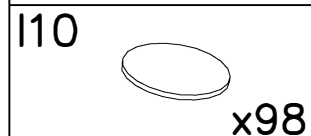
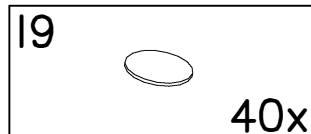
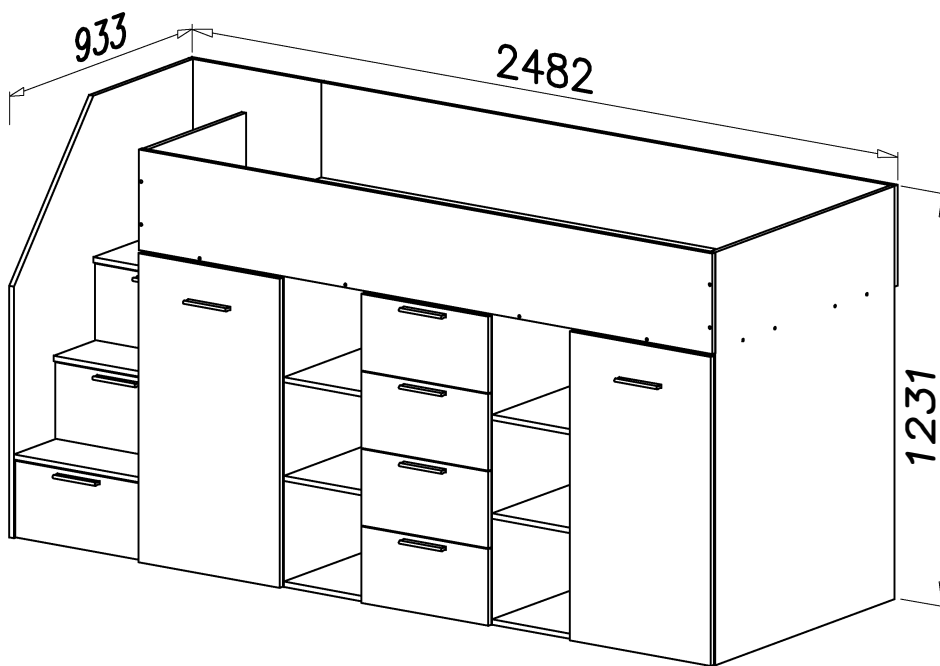

Č .	Dĺžka	Šírka	Hrúbka	Množstvo	Balík
1	880	450	16	1	4/7
2	880	218	16	2	4/7
3	900	450	16	1	4/7
4	680	234	16	2	4/7
5	700	450	16	1	4/7
6	480	234	16	2	4/7
7	500	450	16	1	4/7
8	743	446	3	1	5/7
9	1231	900	16	1	2/7
10	700	440	16	1	1/7
11	700	440	16	1	1/7
12	700	440	16	1	1/7
13	498	250	16	1	1/7
14	158	440	16	1	1/7
15	880	450	16	1	1/7
16	190	440	16	1	1/7
17	190	440	16	1	1/7
18	921	496	16	1	6/7
19	174	440	16	1	1/7
20	931	900	16	1	3/7
21	931	900	16	1	3/7
22	281	900	16	4	2/7

Č .	Dĺžka	Šírka	Hrúbka	Množstvo	Balík
23	931	900	16	1	3/7
24	931	900	16	1	3/7
25	281	70	16	2	2/7
26	418	130	16	2	2/7
27	467	300	16	1	4/7
28	467	300	16	1	4/7
29	467	900	16	1	2/7
30	931	900	16	1	3/7
31	2000	900	16	1	5/7
32	2014	930	16	1	5/7
33	1231	900	16	1	2/7
34	500	283	16	1	1/7
35	2017	300	16	1	5/7
36	2017	300	16	1	5/7
37	445	228	16	4	7/7
38	500	180	16	4	5/7
39	500	180	16	4	5/7
40	361	180	16	4	1/7
41	392	505	3	4	5/7
42	921	496	16	1	6/7
43	446	480	16	1	1/7
44	281	900	16	2	2/7
45	445	228	16	1	7/7
46	445	228	16	2	7/7

1

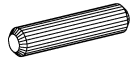
B1 
ø8x30 x8

K1 
ø15x12 x8

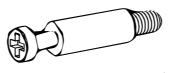
K5 
x8

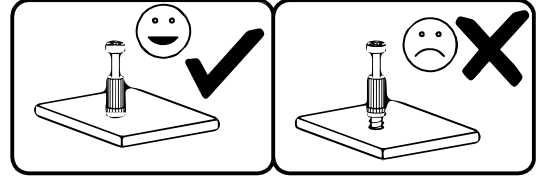
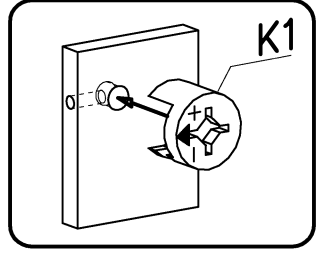
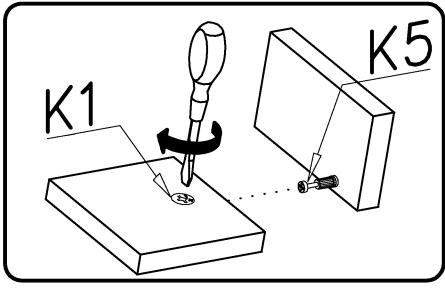
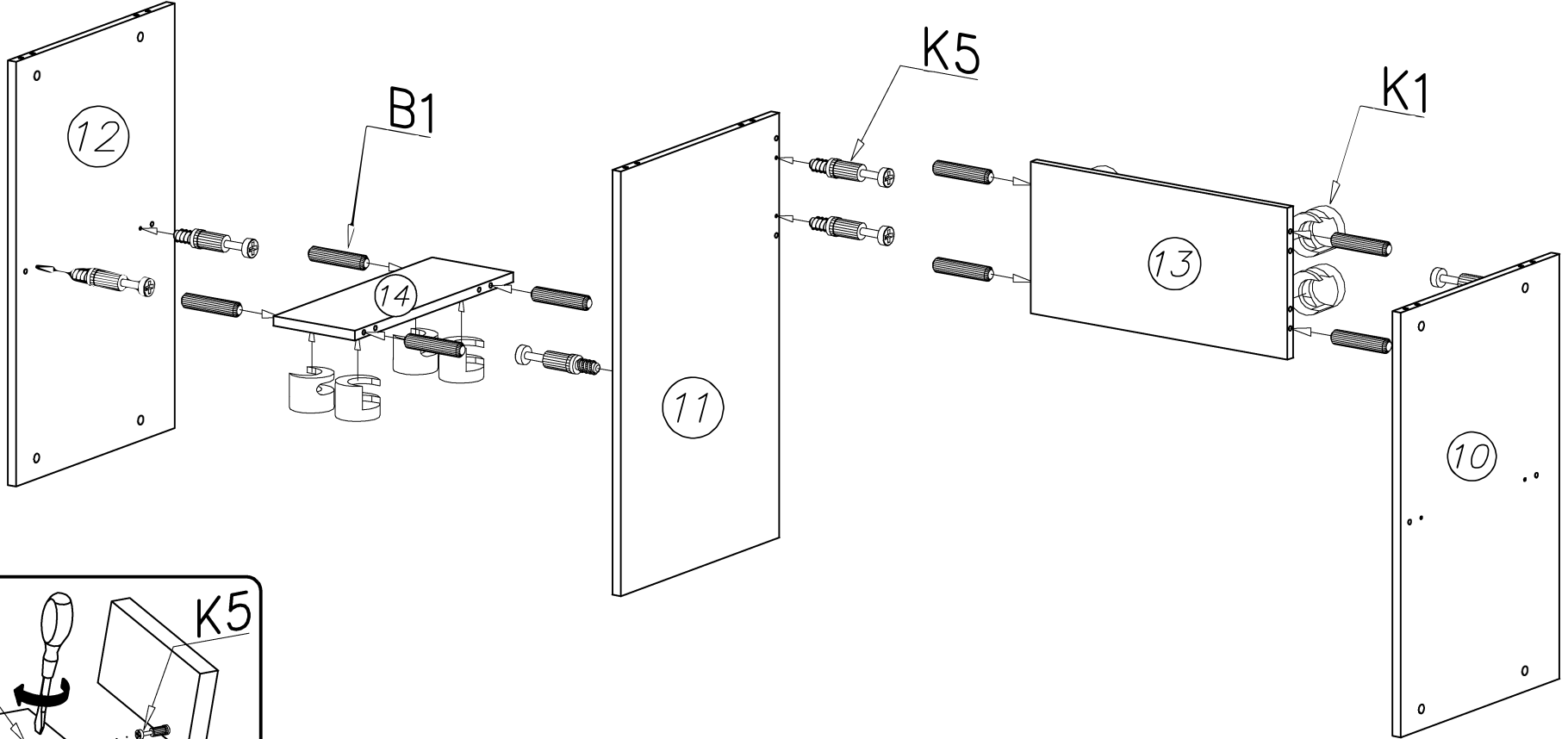

POZOR
Dĺžka vyčnievajúceho kolíka po zasunutí nepresahuje 9-10 mm
Kolíky pritláčajte na miesta označené šípkami

2

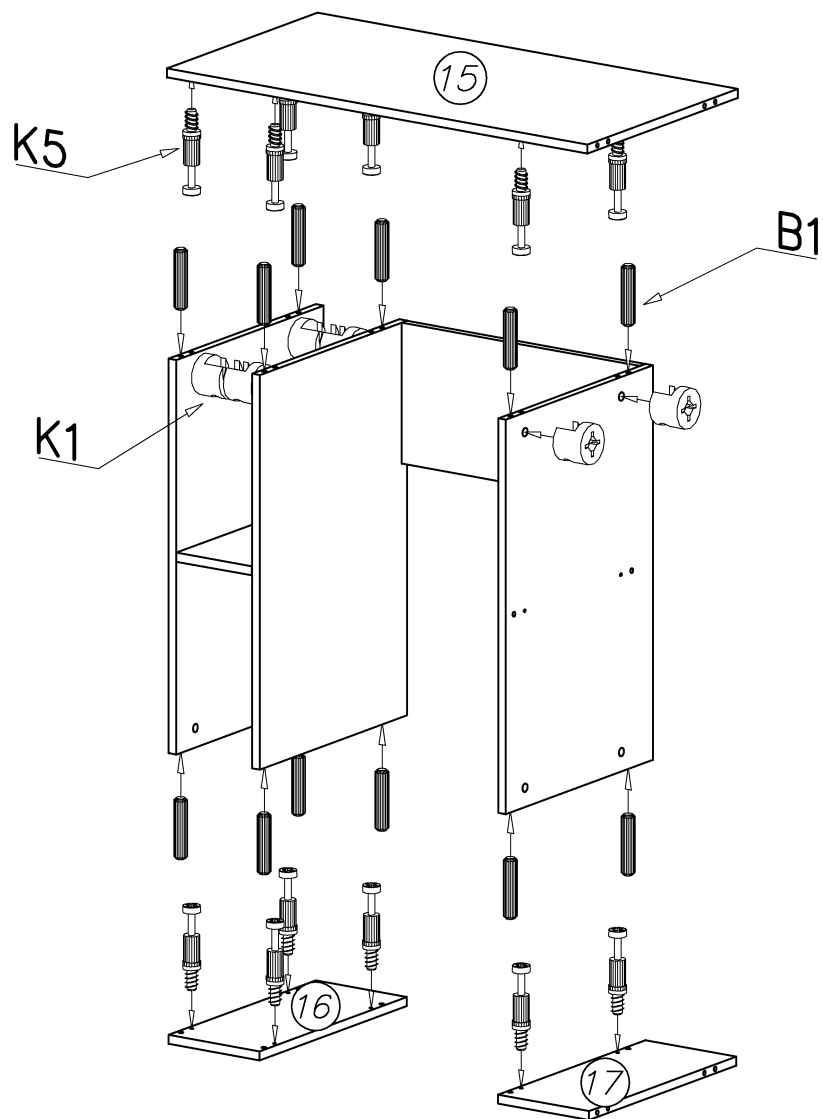

K5		x12
B1		x12
	Ø8x30	
K1		x12
	Ø15x12	

3

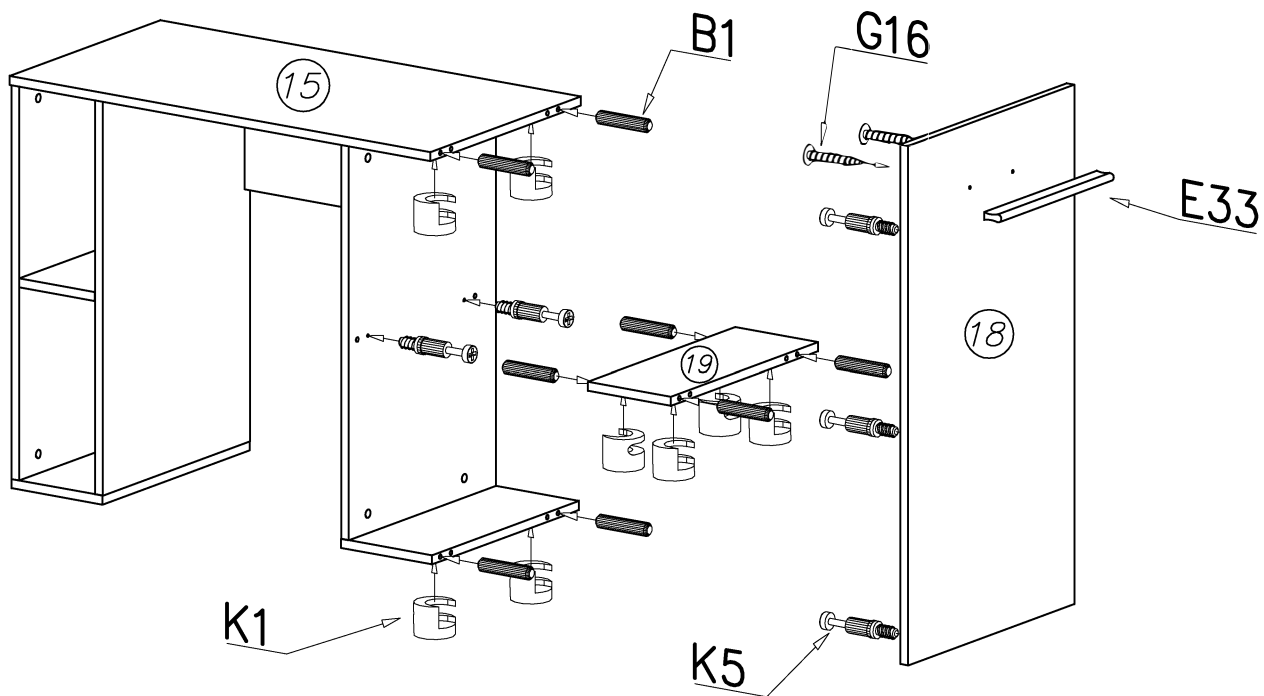

G16		x2	E33		x1	B1		x8	K1		x8	K5		x8
	4x27						Ø8x30			Ø15x12				

POZOR

Dĺžka vyčnievajúceho kolíka po zasunutí nepresahuje 9-10 mm

Kolíky pritláčajte na miesta označené šípkami

4

G4



4x16

P24



x6

x12

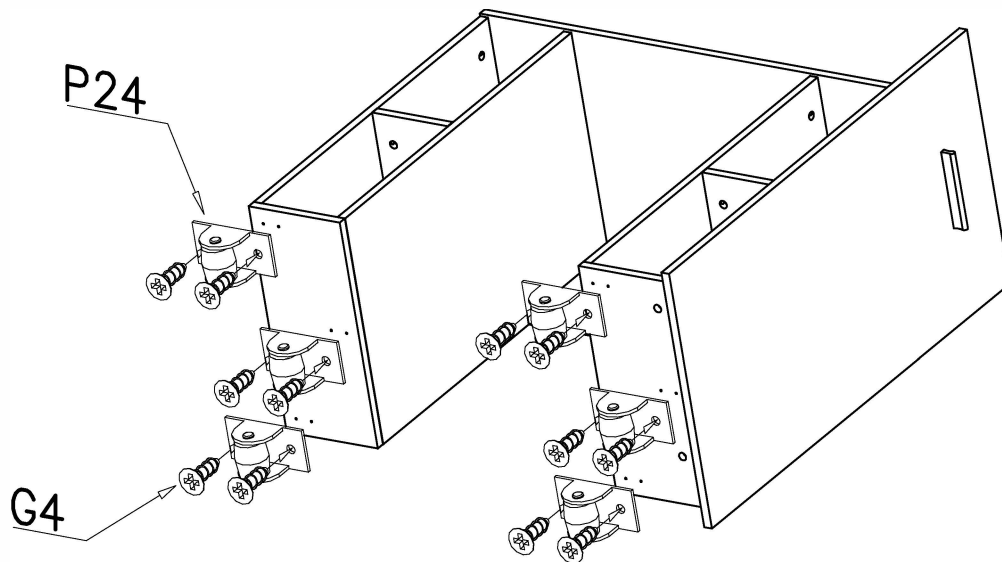

5

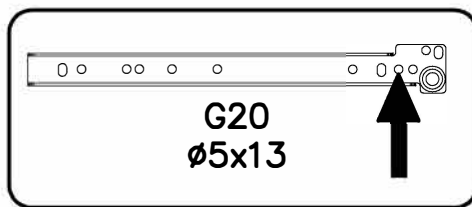
G20
Ø5x13

W4



x8

G20



5x13

x24

H9

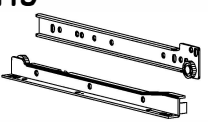

x4

P7

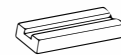

x4

500mm

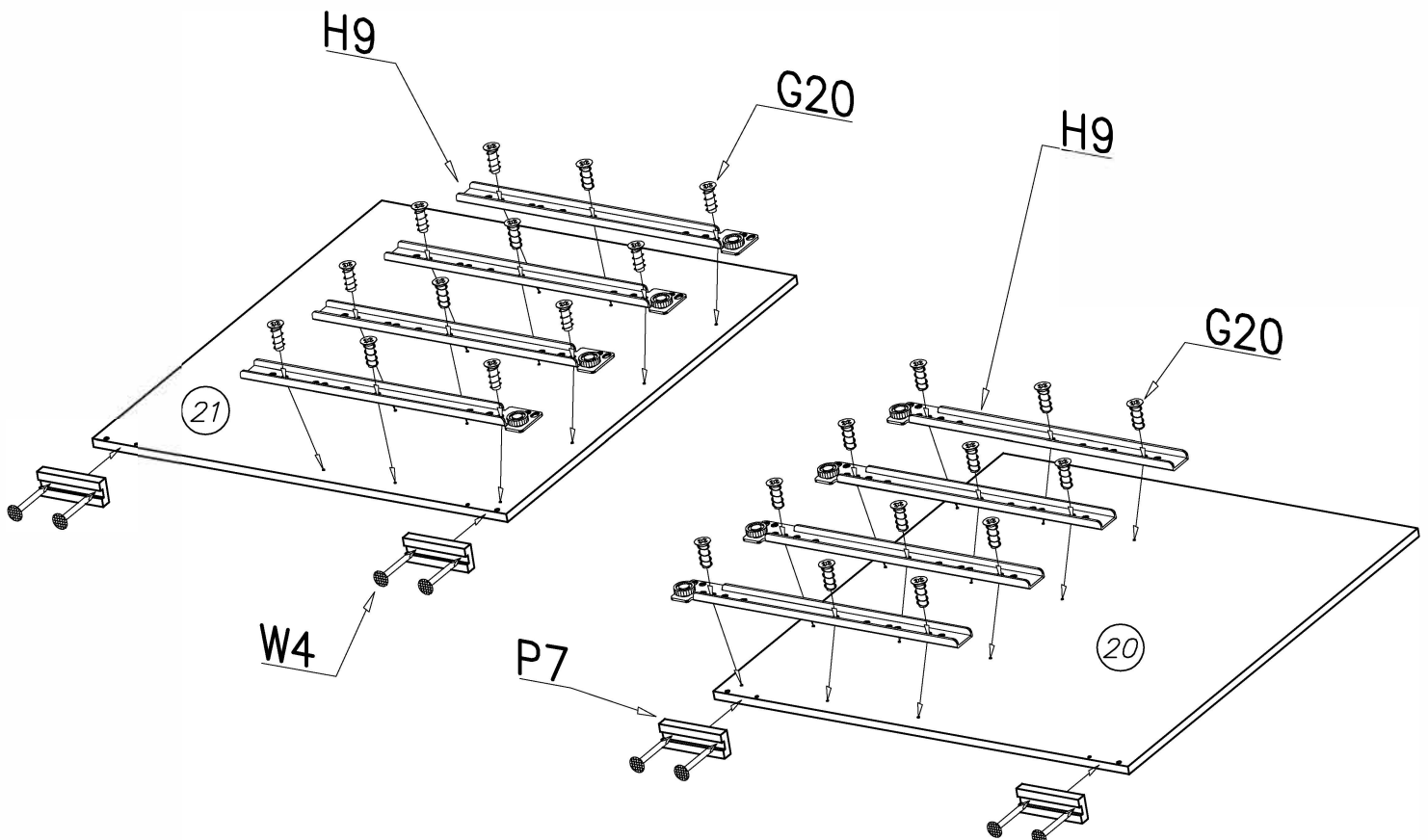
**POZOR**

Dĺžka vyčnievajúceho kolíka po zasunutí nepresahuje 9-10 mm
 Kolíky pritláčajte na miesta označené šípkami

6

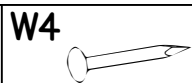

W4

x8

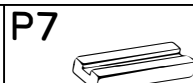

P7

x4

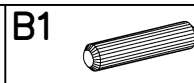

B1

ø8x30

x28

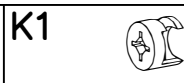

K1

ø15x12

x16

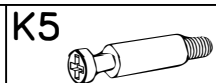

K5

x16

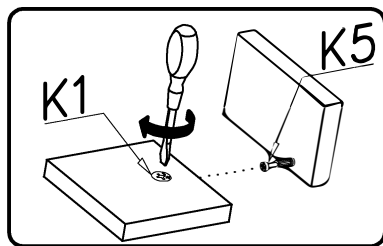
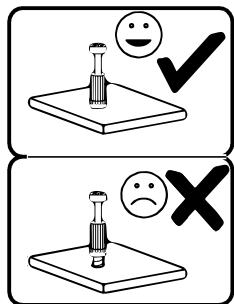
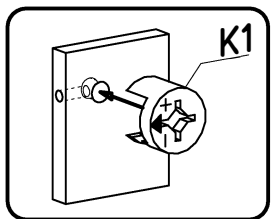
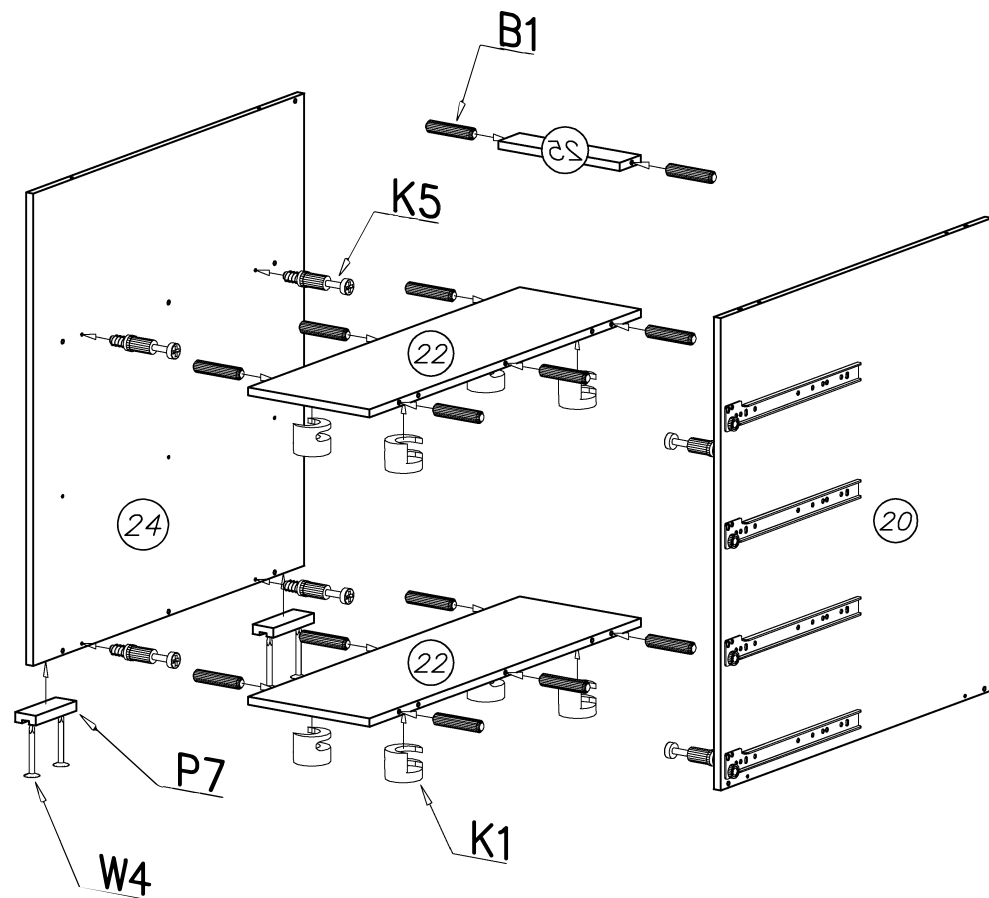
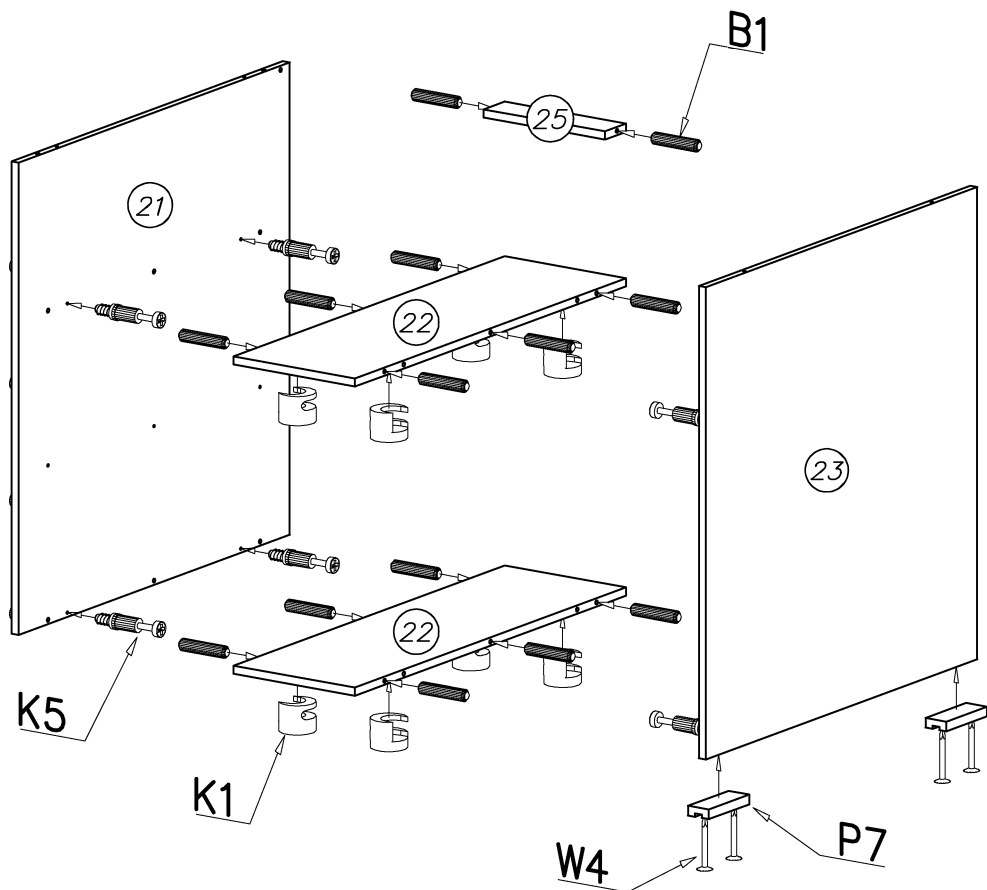
**POZOR**

Dĺžka vyčnievajúceho kolíka po zasunutí nepresahuje 9-10 mm
Kolíky prítlačte na miesta označené šípkami

7

G6
3x12 x2

S4
x2

W4
x4

P7
x2

B1
ø8x30 x16

K1
ø15x12 x12

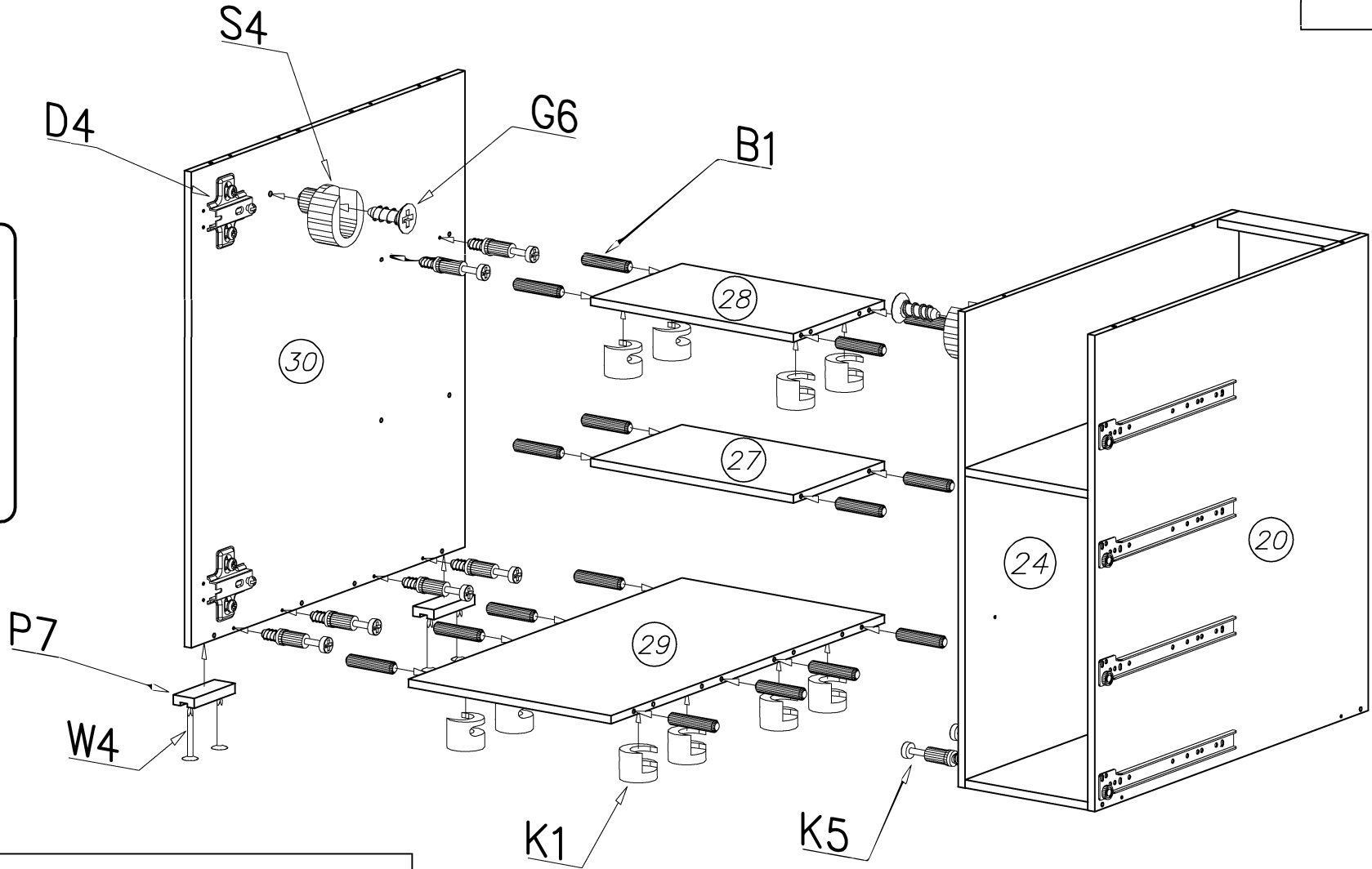
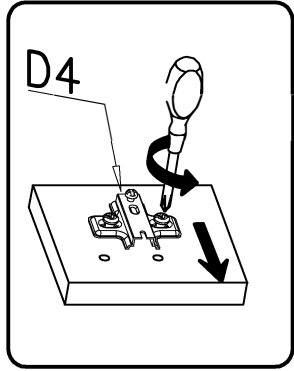

K5
x12

D4
x2



POZOR
Dĺžka vyčnievajúceho kolíka po zasunutí nepresahuje 9-10 mm
Kolíky pritlačte na miesta označené šípkami

8

B1		K1		K5	
Ø8x30	x4	Ø15x12	x4		x4

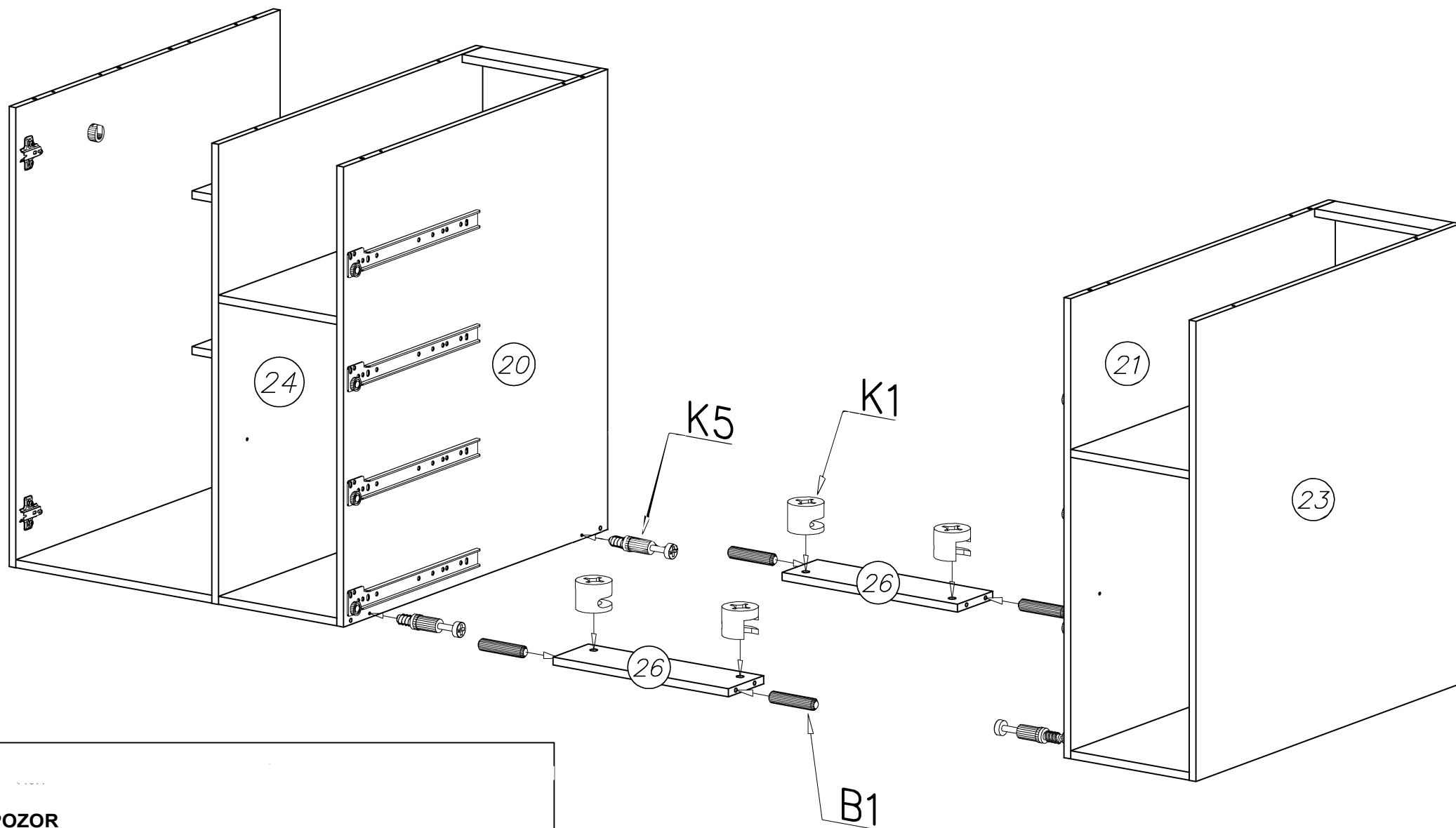

**POZOR**

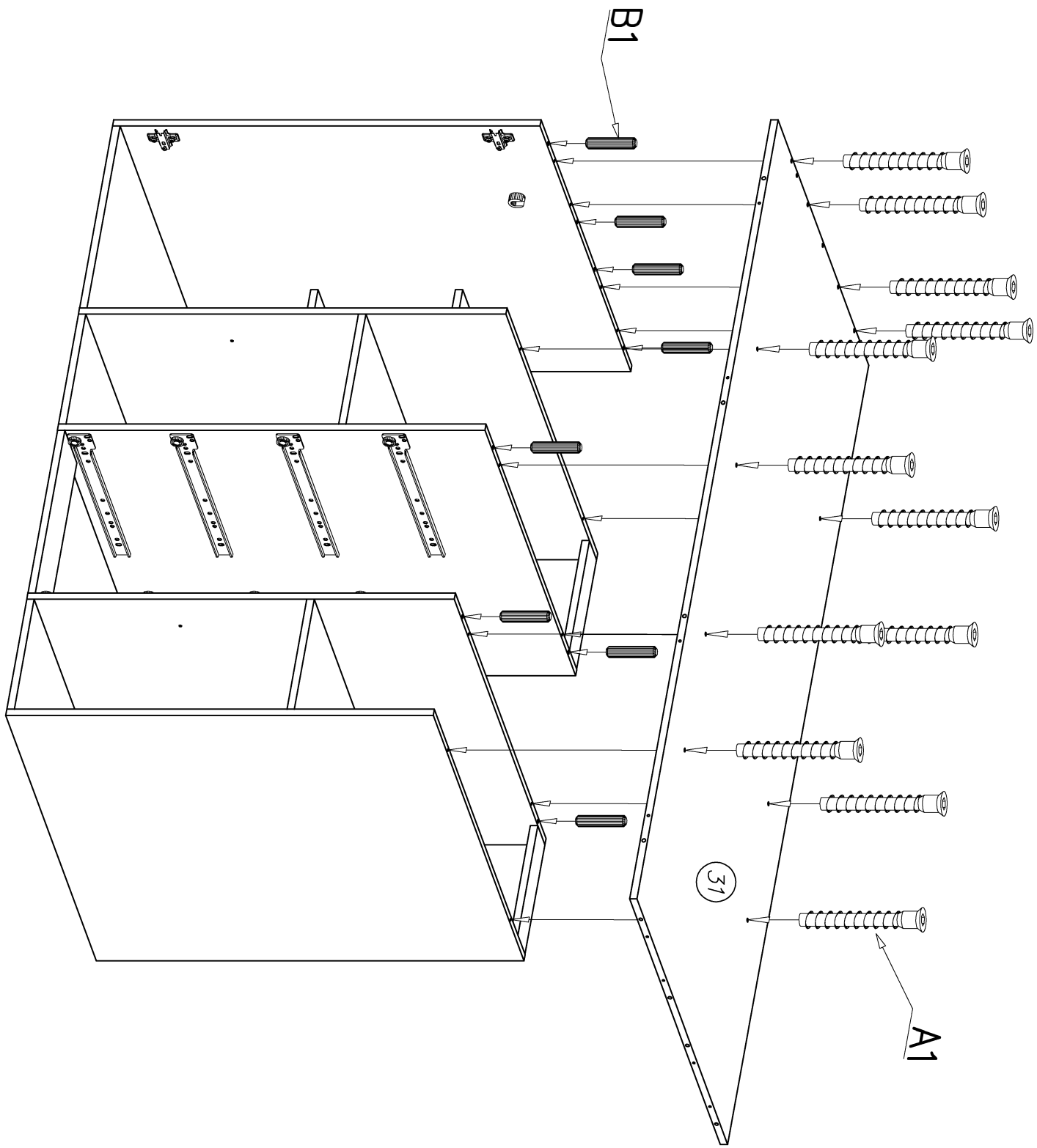
Dĺžka vyčnievajúceho kolíka po zasunutí nepresahuje 9-10 mm
 Kolíky pritláčajte na miesta označené šípkami







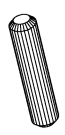

POZOR

Dĺžka vyčnievajúceho kolíka po zasunutí nepresahuje 9-10 mm
 Kolíky prítlačte na miesta označené šípkami

W2		x1
4mm		x12
A1		x12
B1		x8
ø8x30		

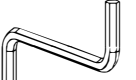
10

W4  x4	P7  x2	B1  $\varnothing 8 \times 30$ x4	K1  $\varnothing 15 \times 12$ x2	K5  x2
W2  4mm x1	A1  $\varnothing 7 \times 50$ x4			

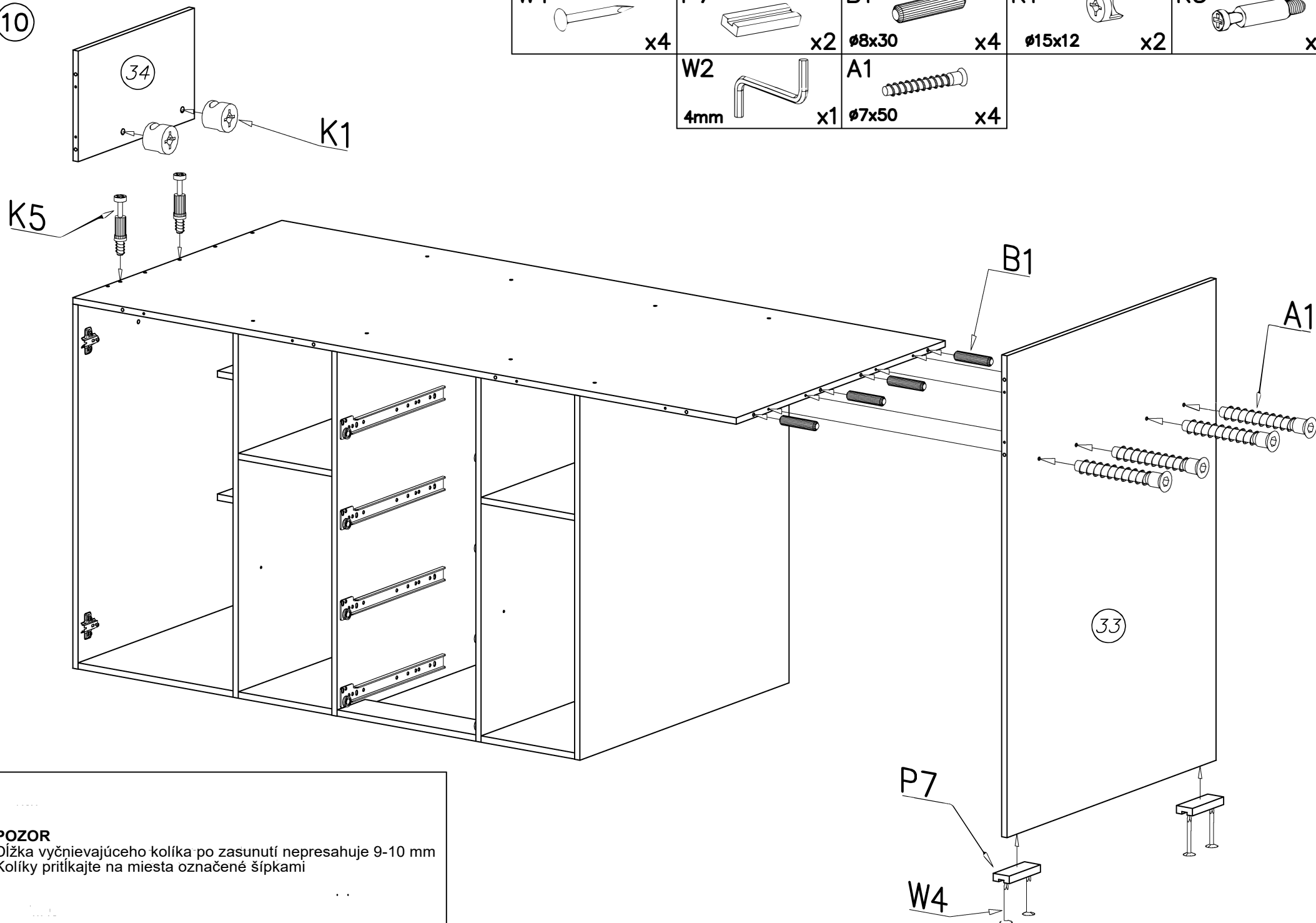

POZOR
 Dĺžka vyčnievajúceho kolíka po zasunutí nepresahuje 9-10 mm
 Kolíky pritláčajte na miesta označené šípkami

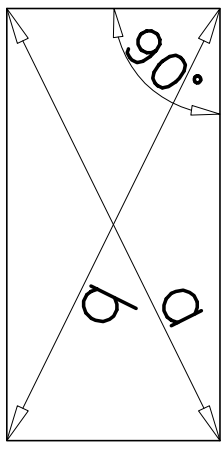

$a = b$

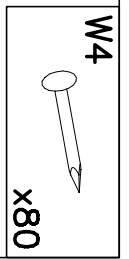
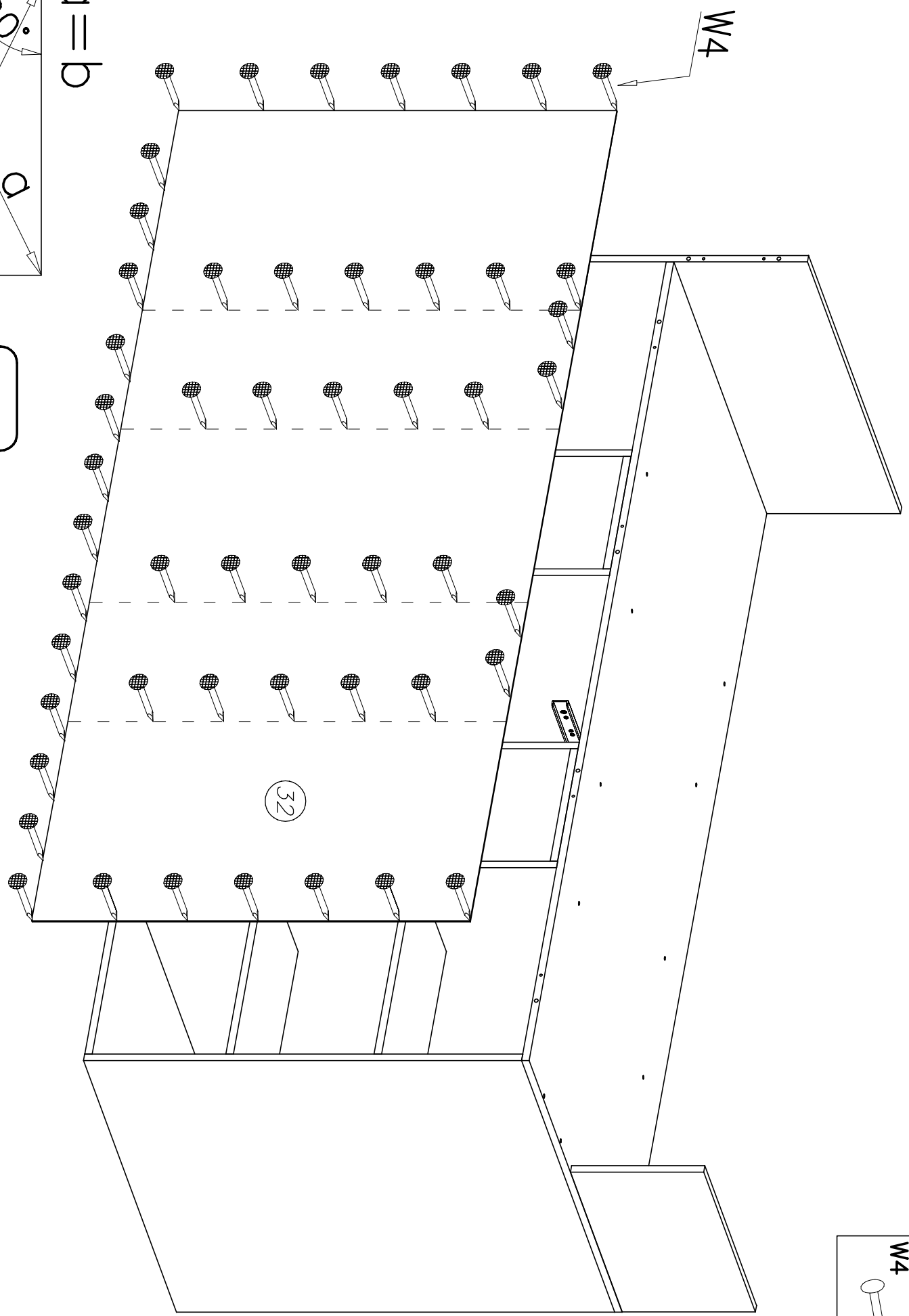

12

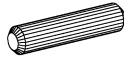
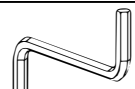
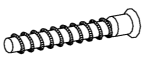
B1		W2		A1	
ø8x30	x14	4mm	x1	ø7x50	x14

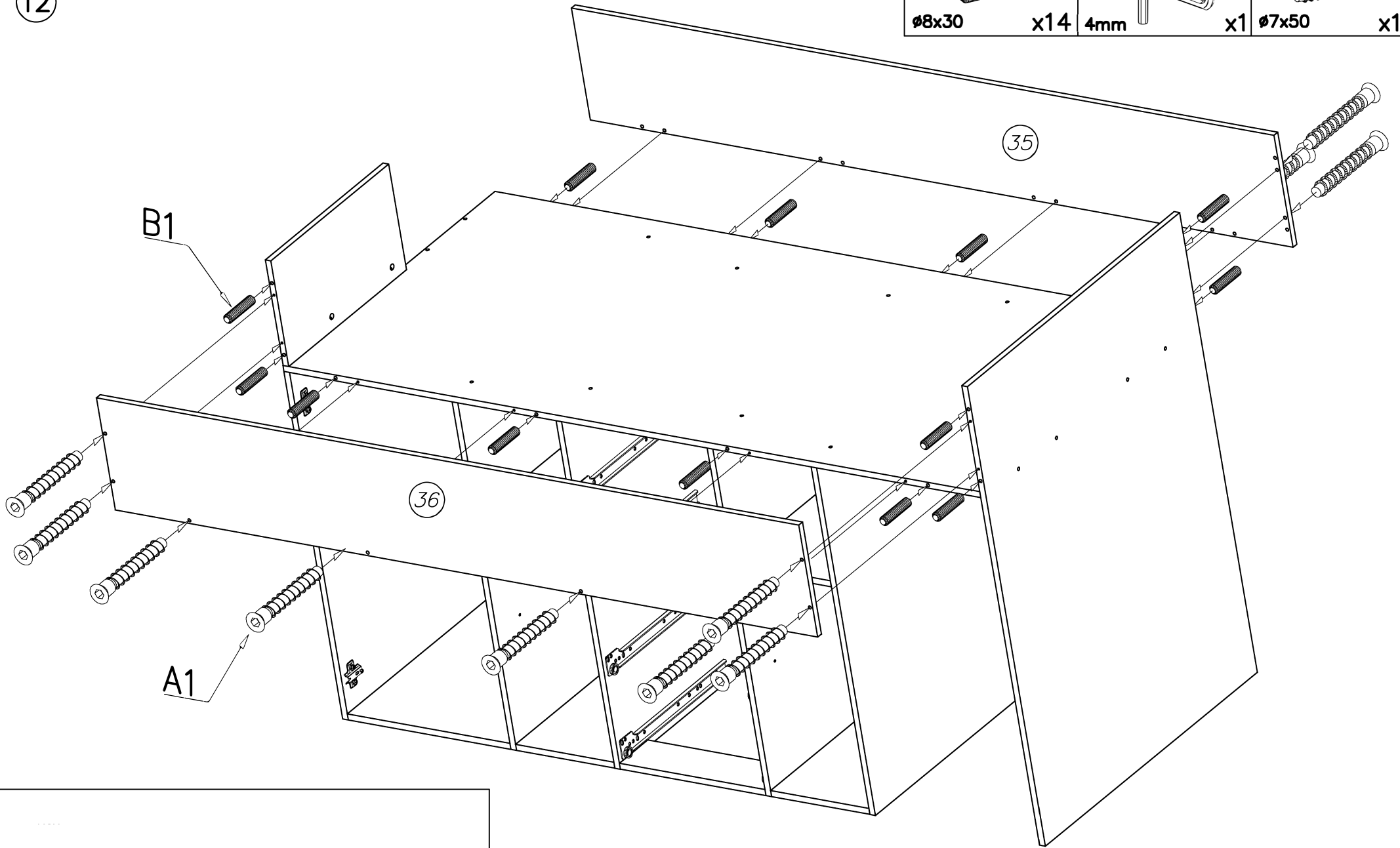

POZOR
Dĺžka vyčnievajúceho kolíka po zasunutí nepresahuje 9-10 mm
Kolíky pritláčajte na miesta označené šípkami

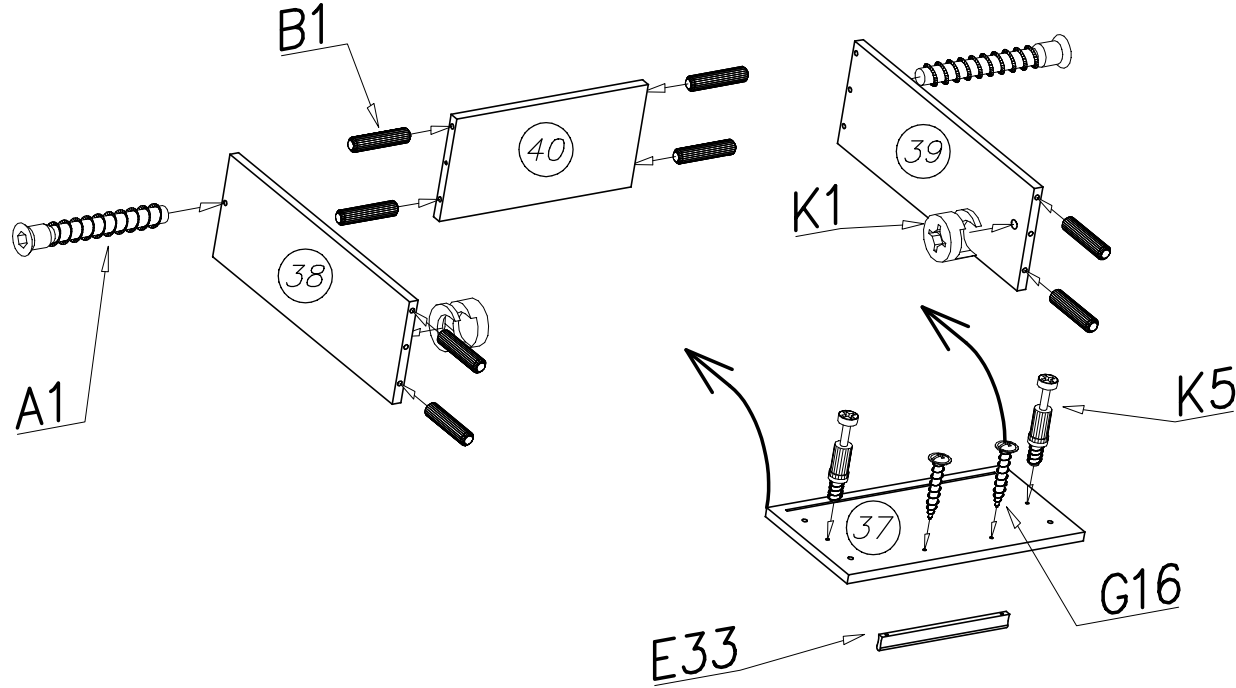

W2
4mm L-shaped corner
x1

W4
Screw
x20

H9
500mm bar
x4

G2
3x20 screw
x24

E33
Thin bar
x4

K1
Ø15x12 roller
x8

K5
Roller
x8

G16
4x27 screw
x8

A1
Ø7x50 spring
x8

B1
Ø8x30 roller
x32

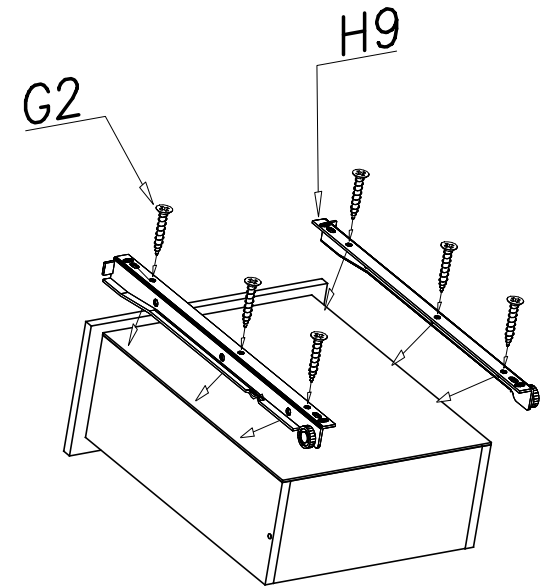
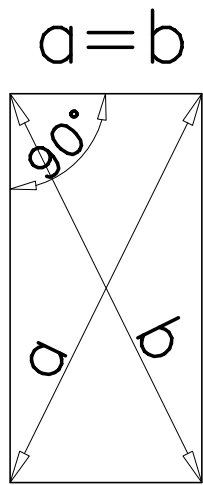
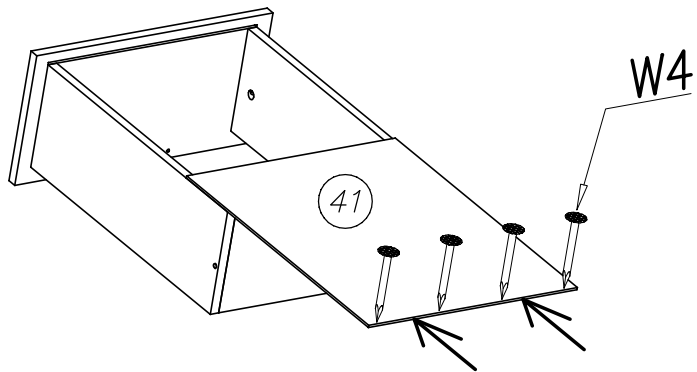

14

G16



4x27

x2

E33

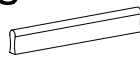

x1

S5



x1

C3

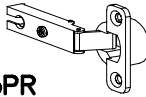

x2

G4



4x16

x4

F2

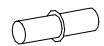

x12

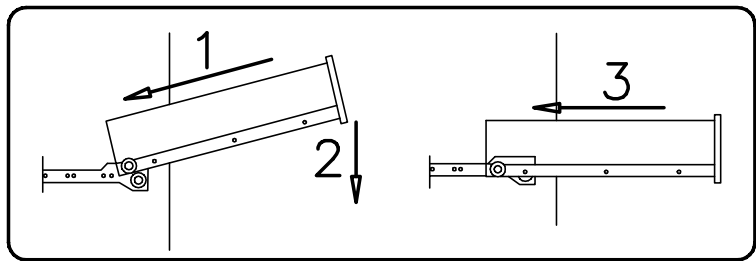
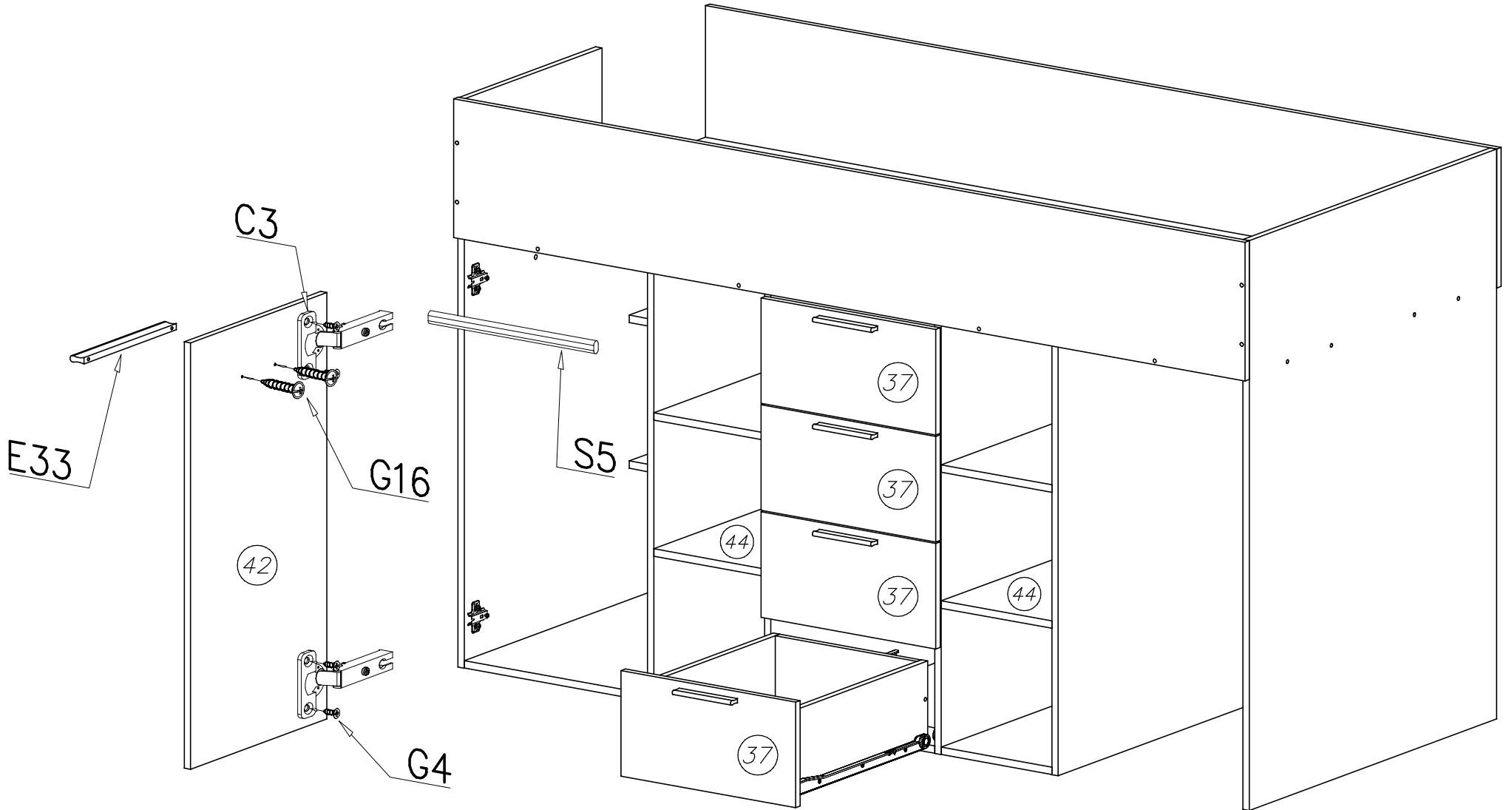

1

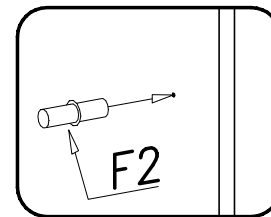

2

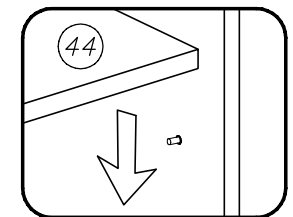



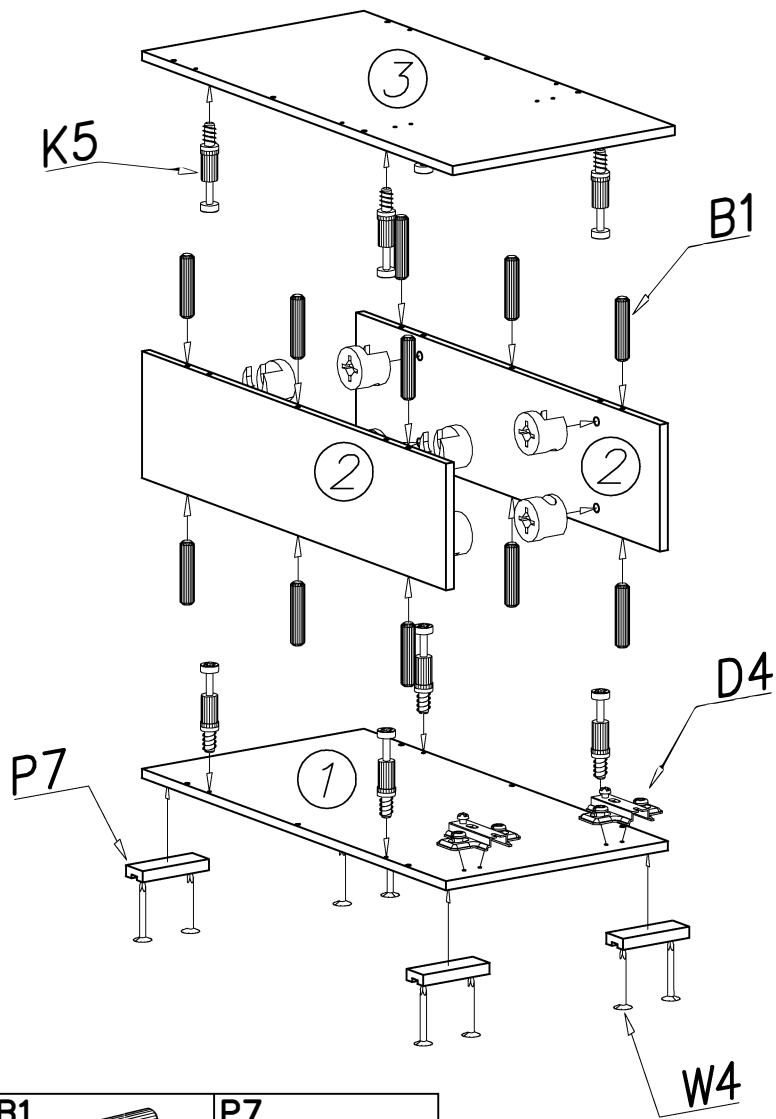

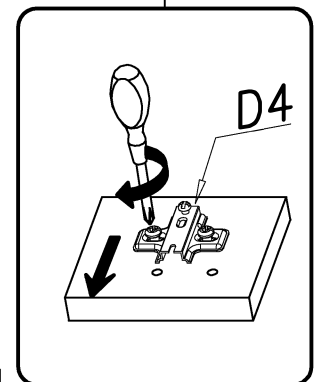
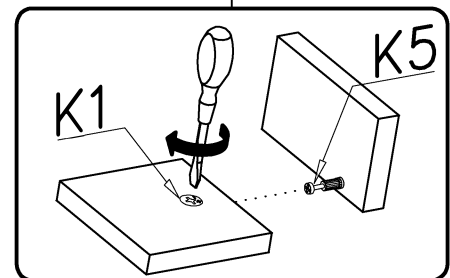
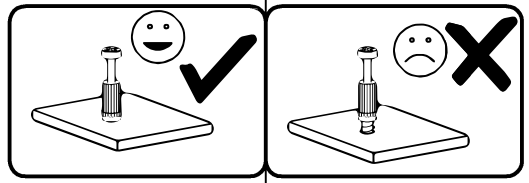
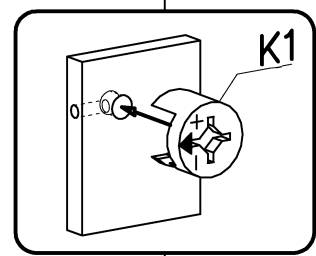
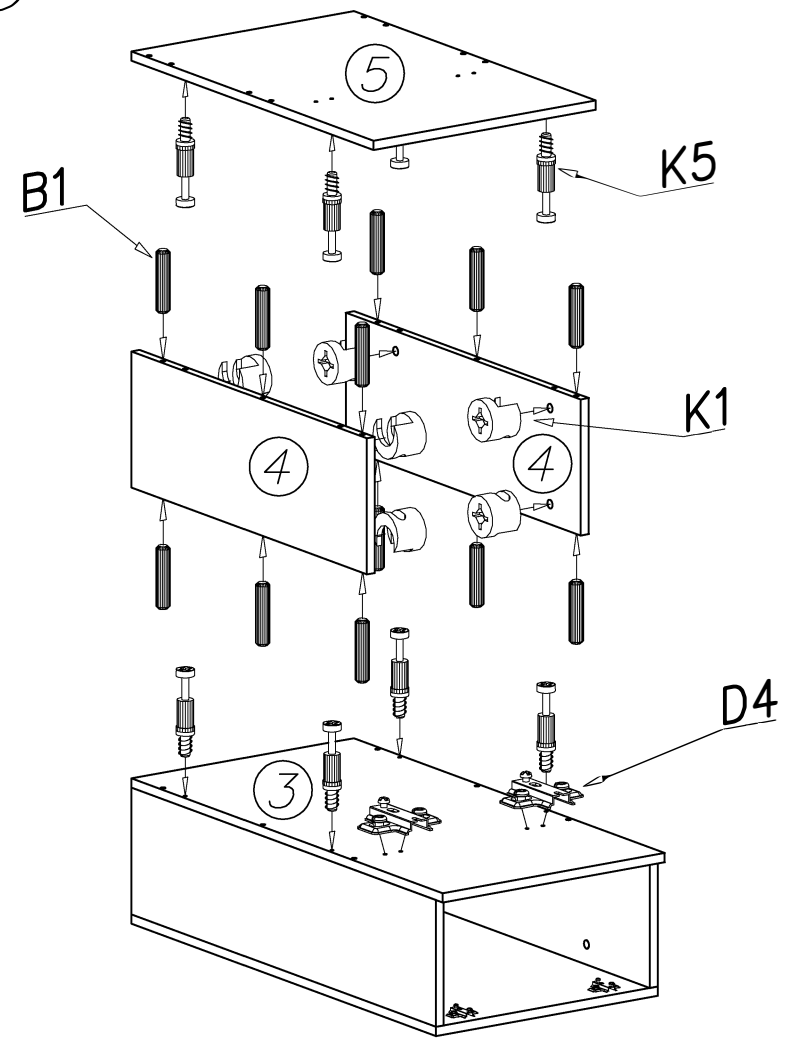

15





16



B1		P7	
ø8x30	x12		x4

D4		W4		K1		K5	
	x2		x8	ø15x12	x8		x8

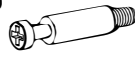
D4		B1		K1		K5	
	x2	ø8x30	x12	ø15x12	x8		x8





POZOR

Dĺžka vyčnievajúceho kolíka po zasunutí nepresahuje 9-10 mm

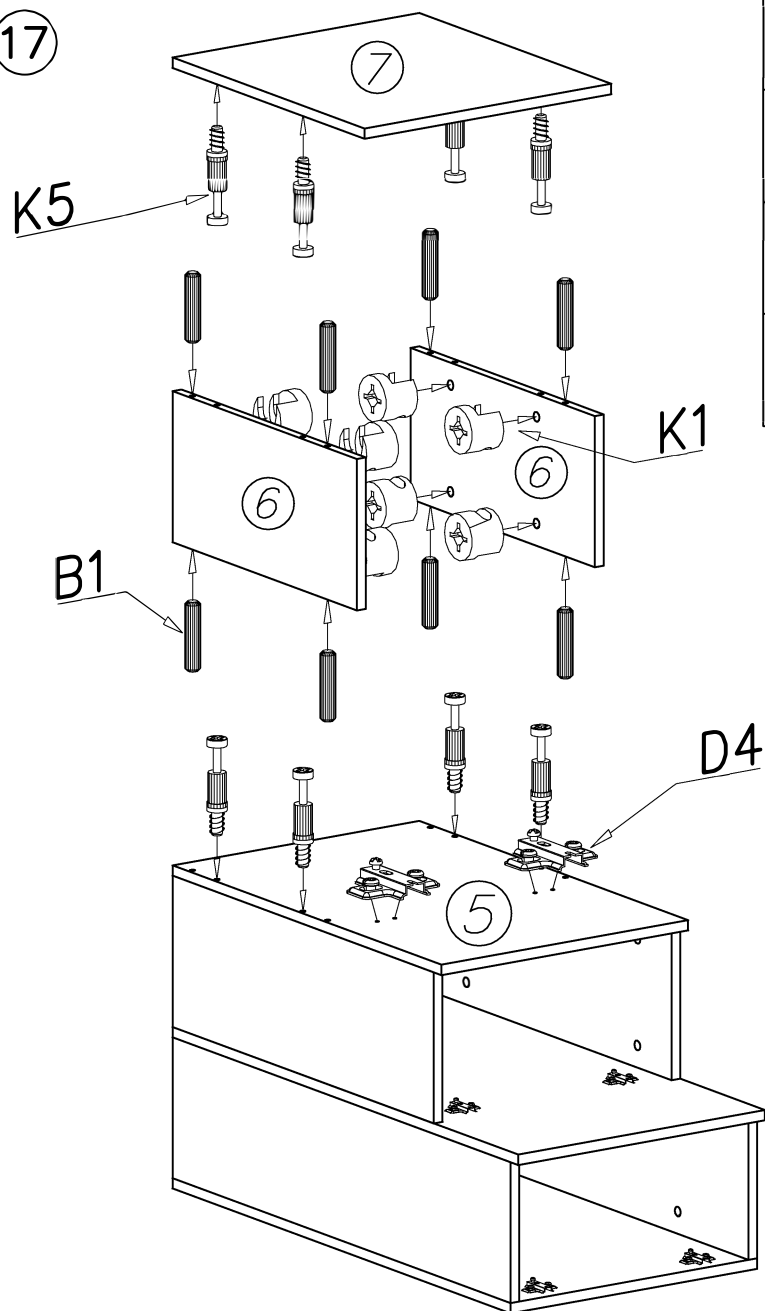
Kolíky pritláčajte na miesta označené šípkami

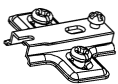
17

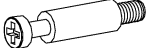

- D4  x2
- B1  x8
- ø8x30  x8
- K1  x8
- ø15x12  x8
- K5  x8

18

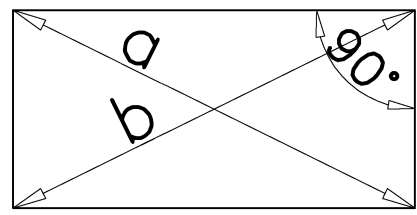
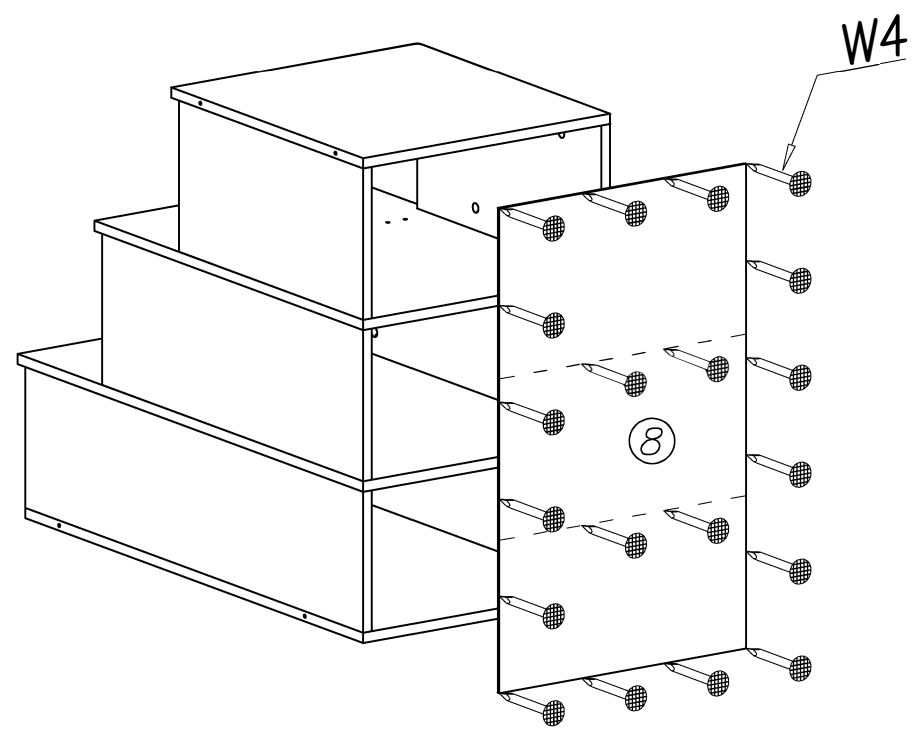

W4  x20



$a = b$

POZOR
 Dĺžka vyčnievajúceho kolíka po zasunutí nepresahuje 9-10 mm
 Kolíky pritláčajte na miesta označené šípkami

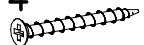
19

- G14  3,5x45 x4
- P7  x2
- W4  x4

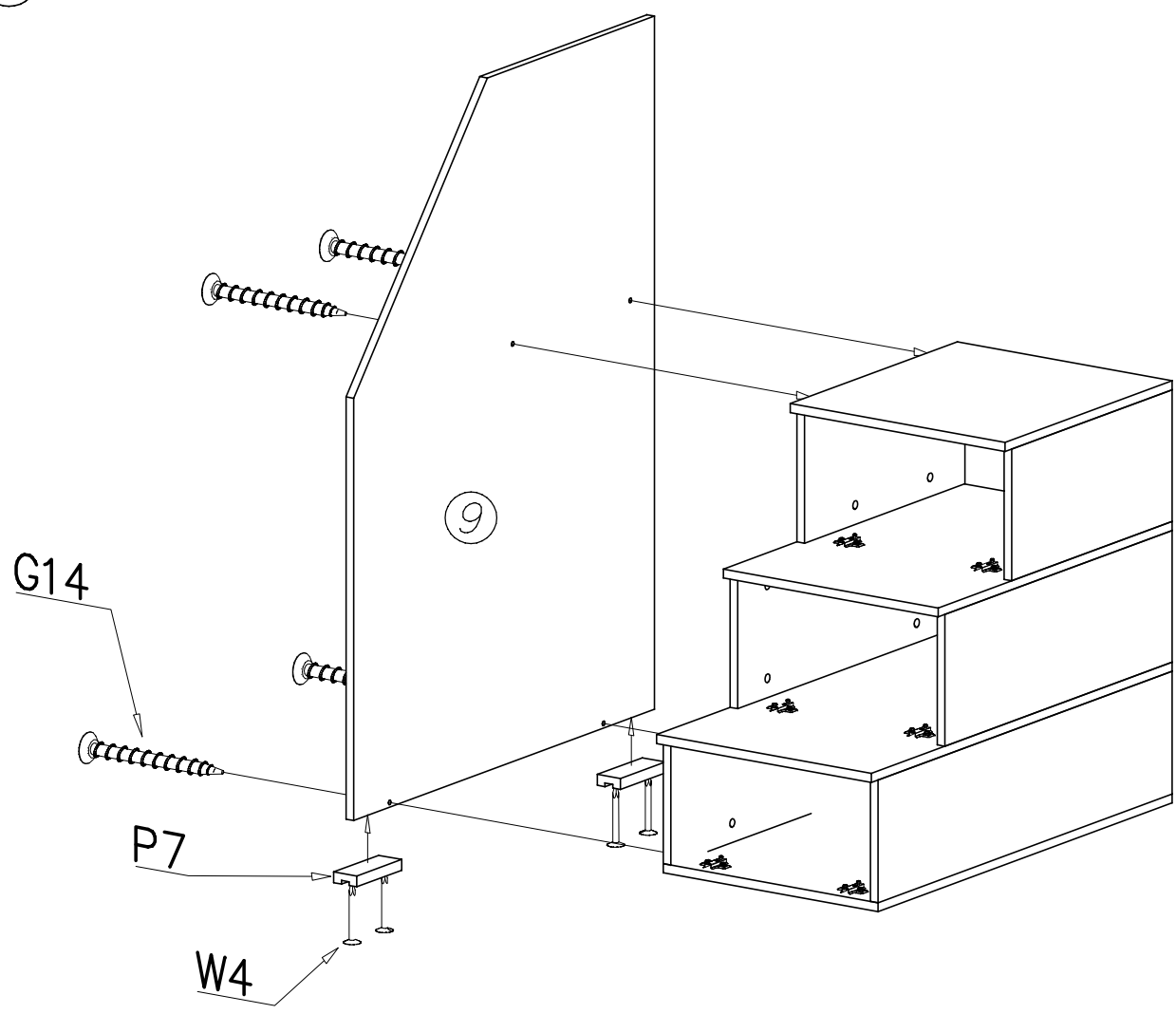



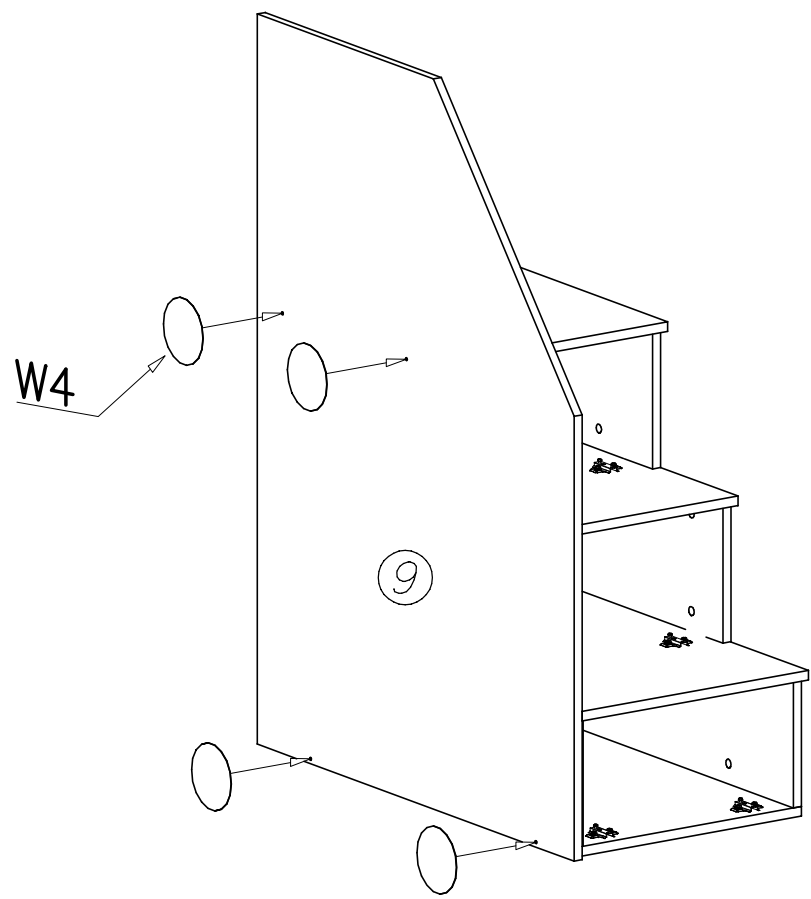

20

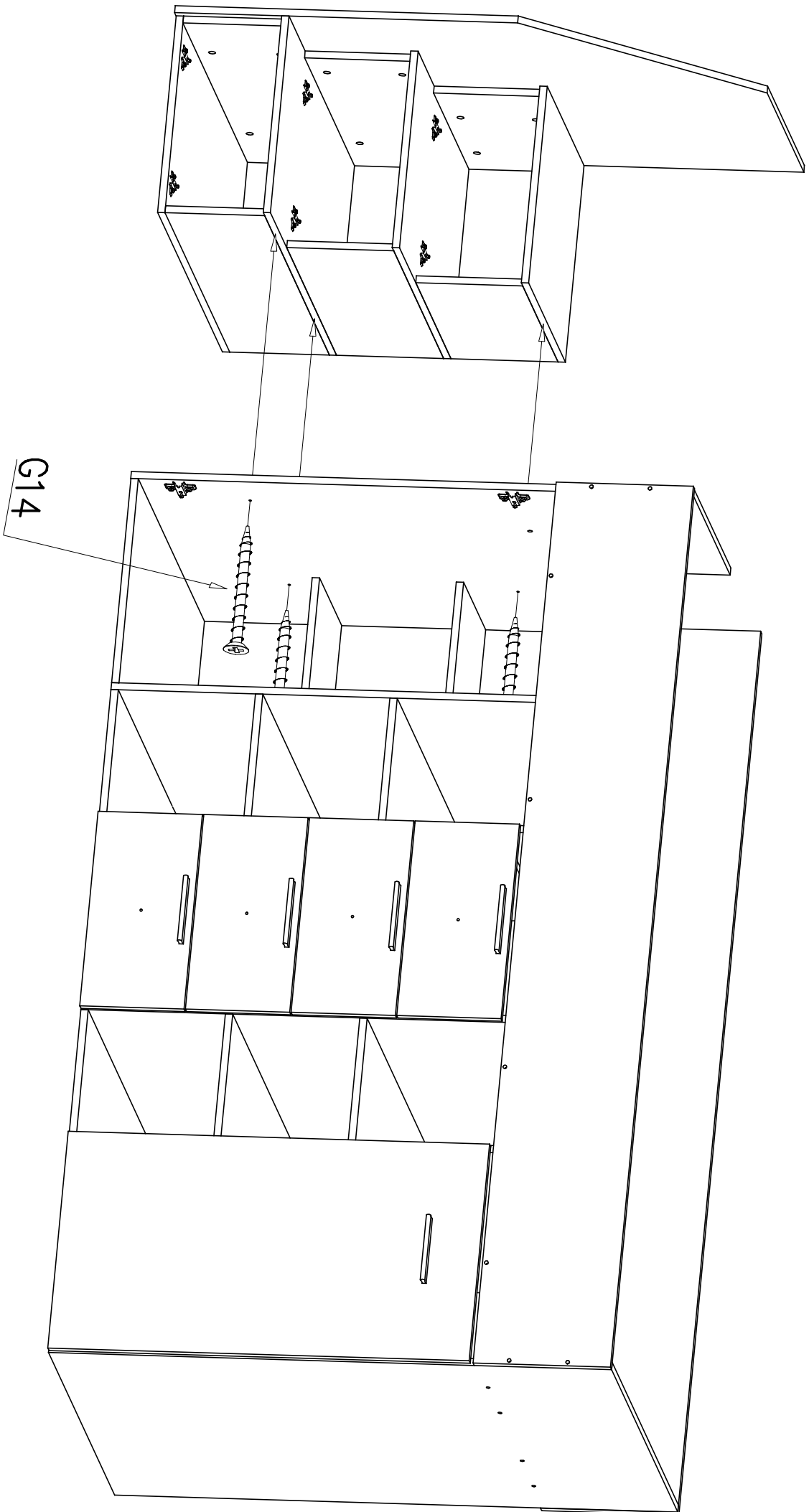
- I10  x4



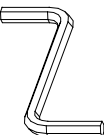





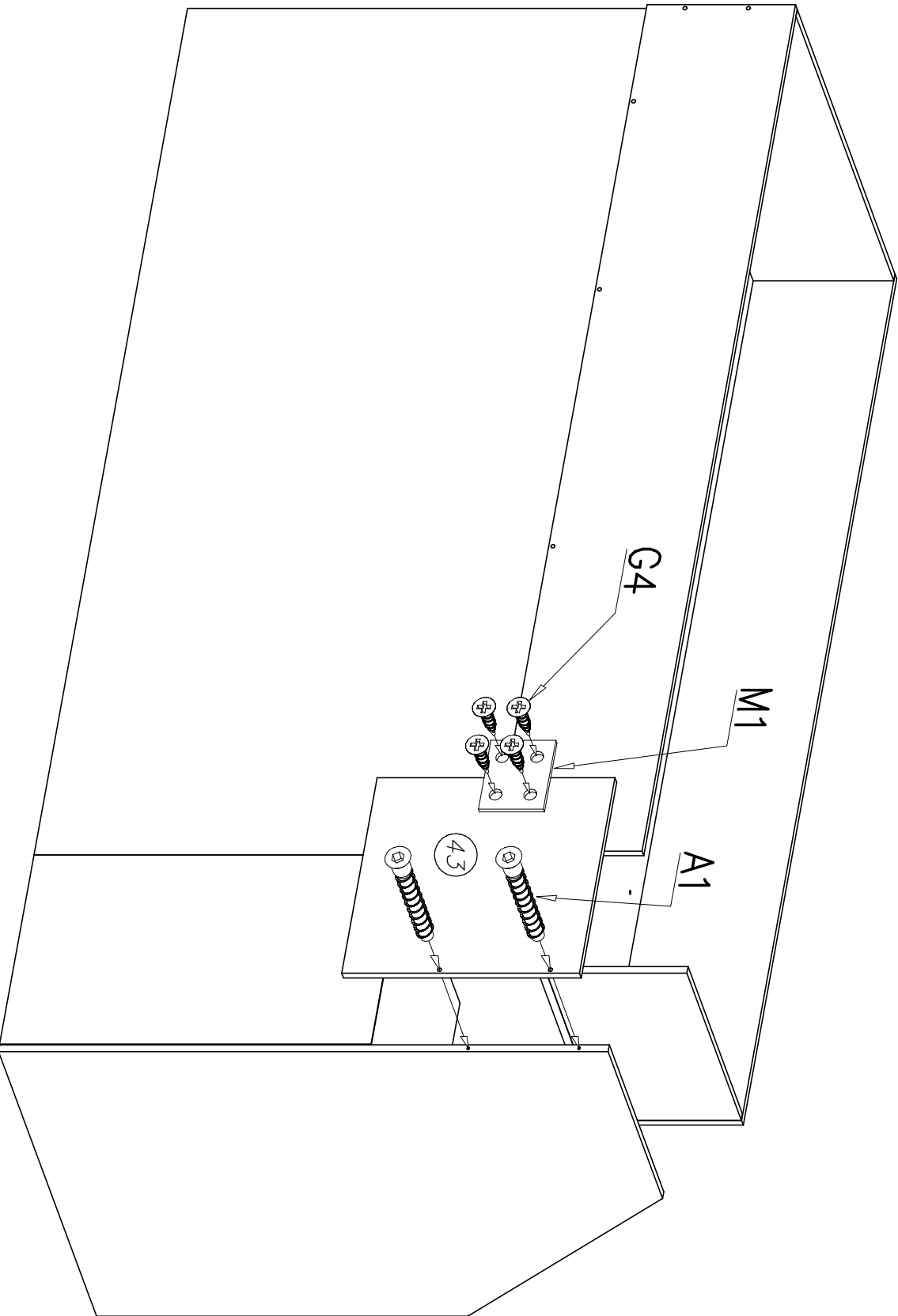

G14
3,5x45 X3

W2 4mm 	A1 ø7x50 	M1 	G4 4x16 
X1	X2	X1	X4

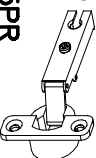

23

19		110		G16		E33		G4		C3		C4	
	40x		x94	4x27	x6	x3	x3	4x16	x12	Z35PR	x2	Z35OD	x4

