

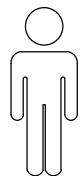

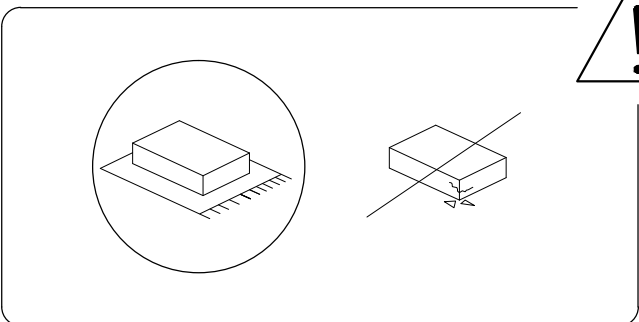

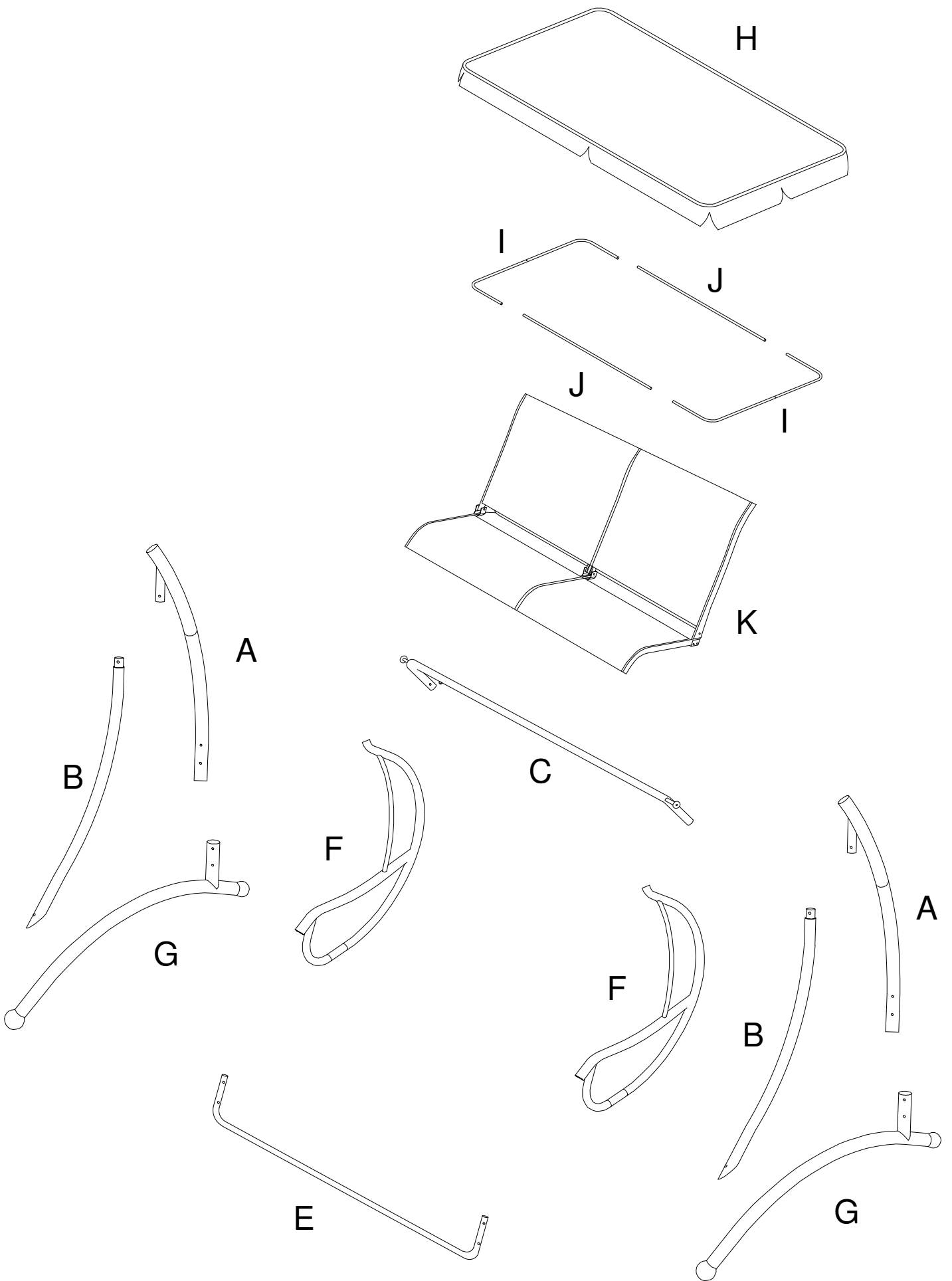



60'

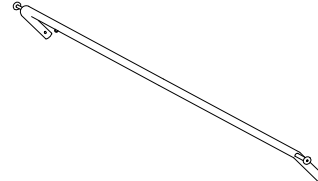
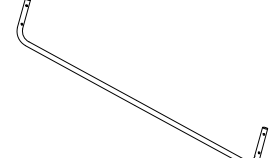

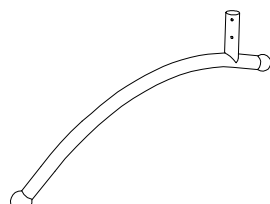
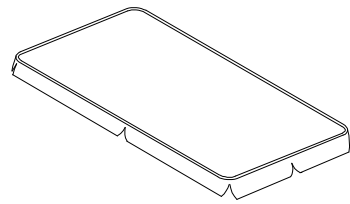
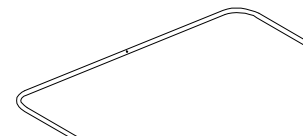
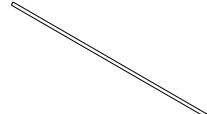
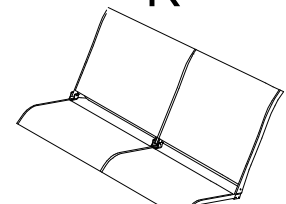
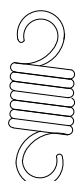
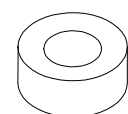

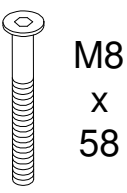
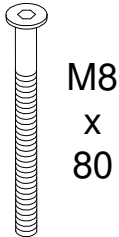
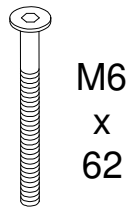
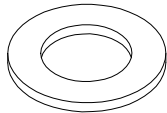
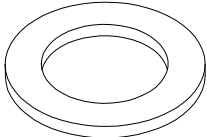
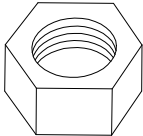
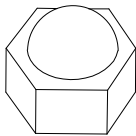
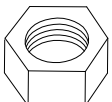
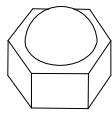

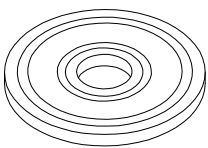
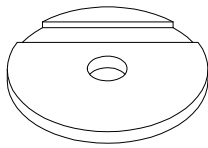
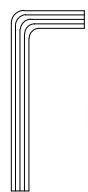

2



<p><b>A</b></p>  <p><b>x 2</b></p>	<p><b>B</b></p>  <p><b>x 2</b></p>	<p><b>C</b></p>  <p><b>x 1</b></p>
<p><b>E</b></p>  <p><b>x 1</b></p>	<p><b>F</b></p>  <p><b>x 2</b></p>	<p><b>G</b></p>  <p><b>x 2</b></p>
<p><b>H</b></p>  <p><b>x 1</b></p>	<p><b>I</b></p>  <p><b>x 2</b></p>	<p><b>J</b></p>  <p><b>x 2</b></p>
<p><b>K</b></p>  <p><b>x 1</b></p>	<p><b>M</b></p>  <p><b>x 2</b></p>	<p><b>O</b></p>  <p><b>x 4</b></p>

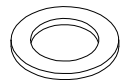
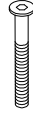
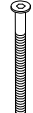



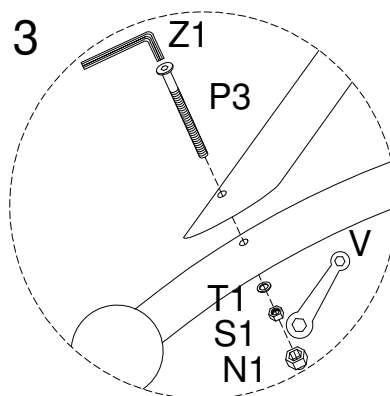
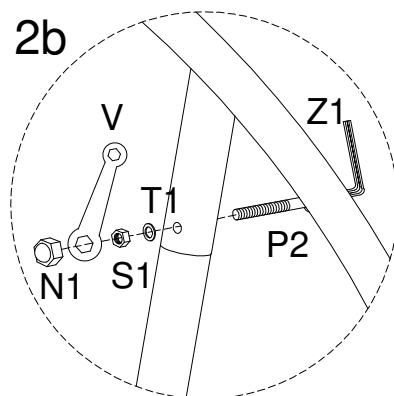
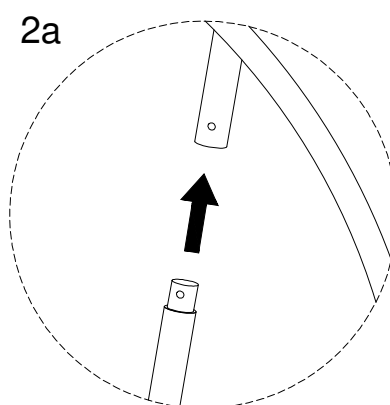
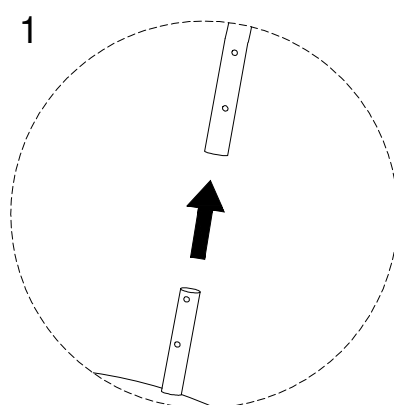
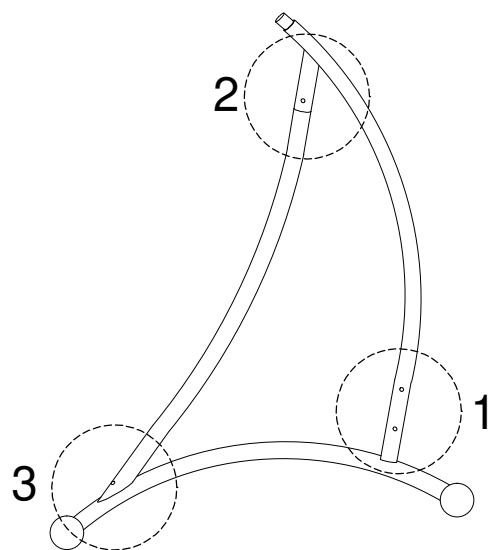

<p><b>P2</b></p>  <p>M8 x 58</p> <p>x 6</p>	<p><b>P3</b></p>  <p>M8 x 80</p> <p>x 6</p>	<p><b>P4</b></p>  <p>M6 x 62</p> <p>x 4</p>	
<p><b>T</b></p>  <p>x 4</p>	<p><b>T1</b></p>  <p>x 10</p>	<p><b>S1</b></p>  <p>x 10</p>	
<p><b>N1</b></p>  <p>x 10</p>	<p><b>S</b></p>  <p>x 4</p>	<p><b>N</b></p>  <p>x 4</p>	<p><b>V</b></p>  <p>x 1</p>
<p><b>X</b></p>  <p>x 2</p>	<p><b>Y</b></p>  <p>x 4</p>	<p><b>Z1</b></p>  <p>M8</p> <p>x 1</p>	<p><b>Z2</b></p>  <p>M6</p> <p>x 1</p>

1 x 2

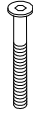
<p>A</p>  <p>x 1</p>	<p>B</p>  <p>x 1</p>	<p>G</p>  <p>x 1</p>	<p>T1</p>  <p>x 2</p>	<p>P2</p>  <p>M8 x 58</p> <p>x 1</p>
<p>P3</p>  <p>M8 x 80</p> <p>x 1</p>	<p>S1</p>  <p>x 2</p>	<p>N1</p>  <p>x 2</p>	<p>V</p>  <p>x 1</p>	<p>Z1</p>  <p>M8</p> <p>x 1</p>







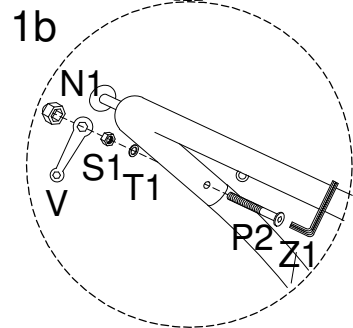
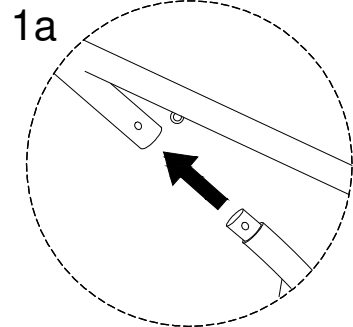
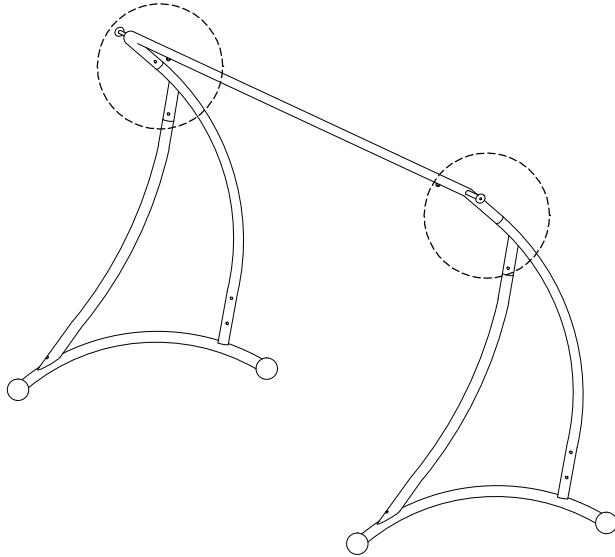

2

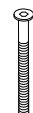
C	P2	T1	S1	N1	V	Z1
	 M8 x 58					 M8
x 1	x 2	x 2	x 2	x 2	x 1	x 1







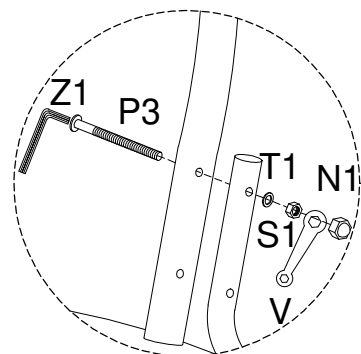
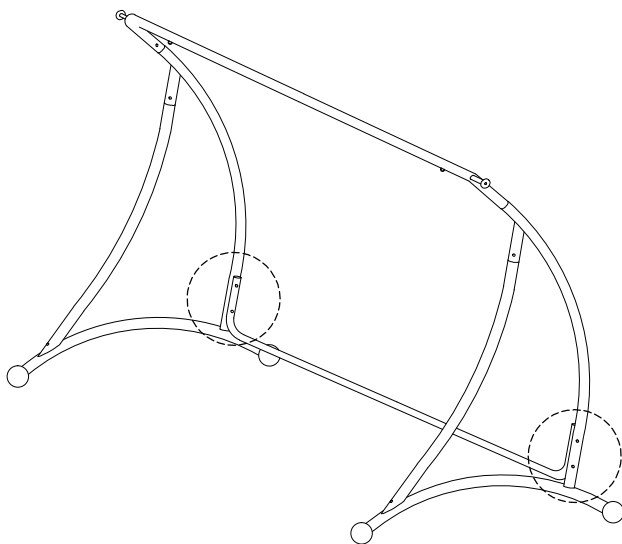

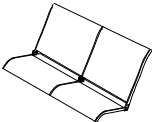

3

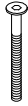
E	P3	T1	S1	N1	V	Z1
	 M8 x 80					 M8
x 1	x 4	x 4	x 4	x 4	x 1	x 1



4

<p>F</p>  <p>x 2</p>	<p>K</p>  <p>x 1</p>	<p>O</p>  <p>x 4</p>	<p>P4</p>  <p>M6 x 62 x 4</p>	
<p>T</p>  <p>x 4</p>	<p>P</p>  <p>x 4</p>	<p>N</p>  <p>x 4</p>	<p>V</p>  <p>x 1</p>	<p>Z2</p>  <p>M6 x 1</p>

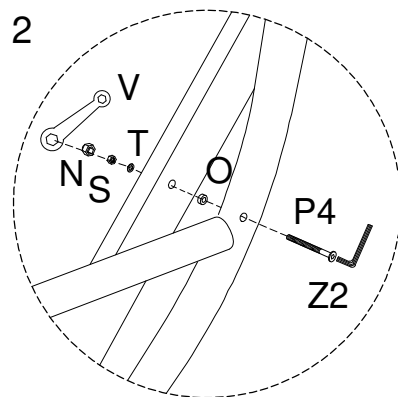
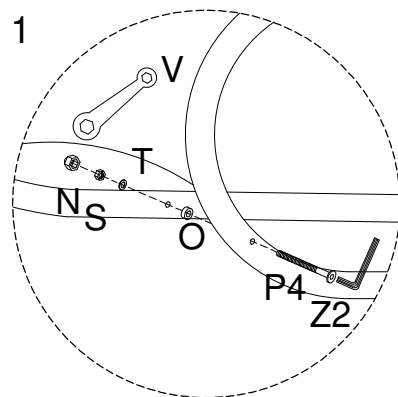
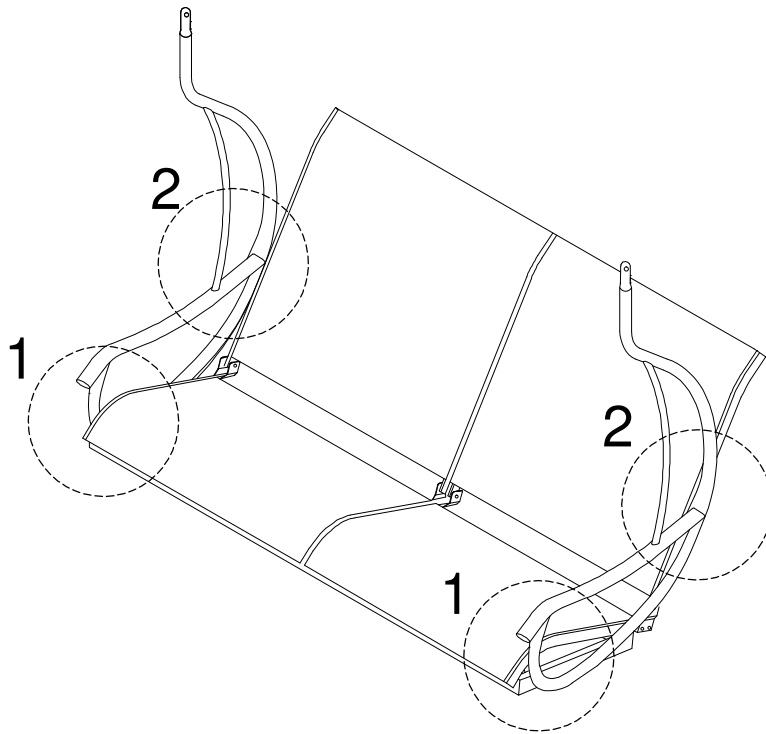

5

M  
  
x 2

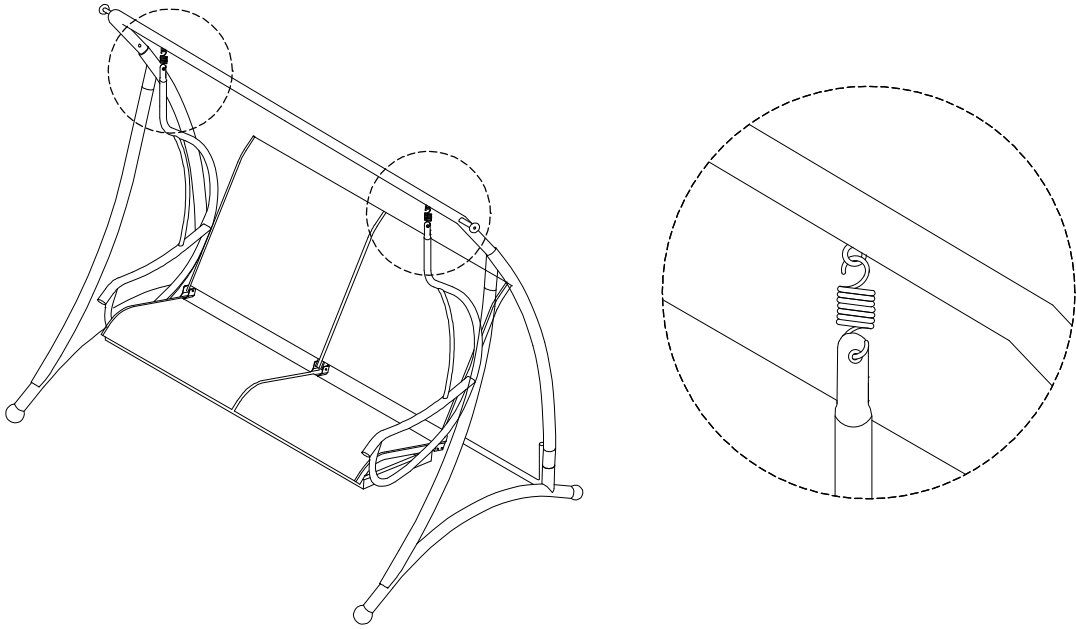

6

I  
  
x 2

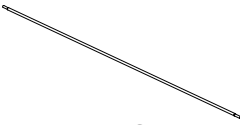
J  
  
x 2

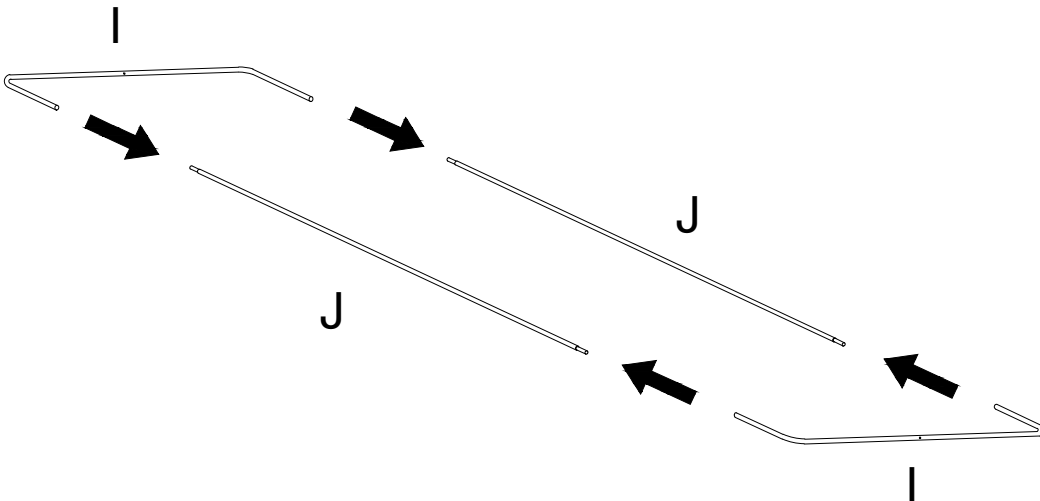



7

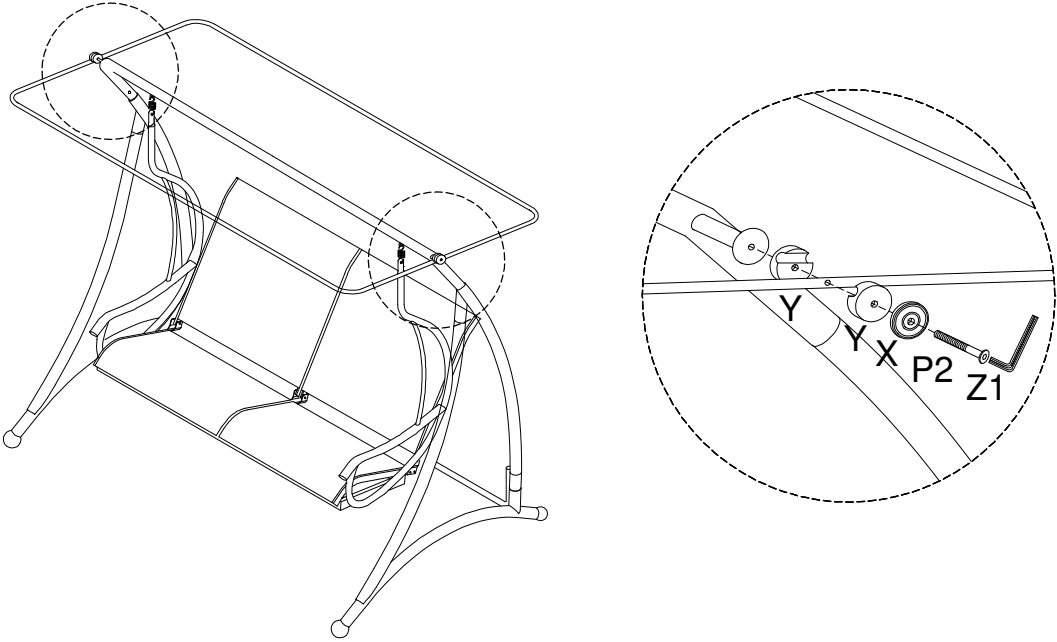
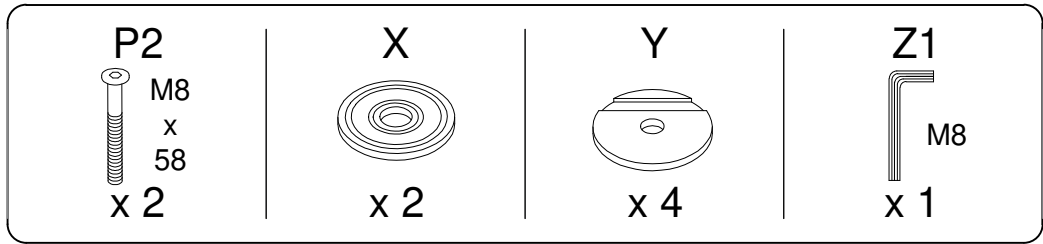

8

