

20'

1

1/4

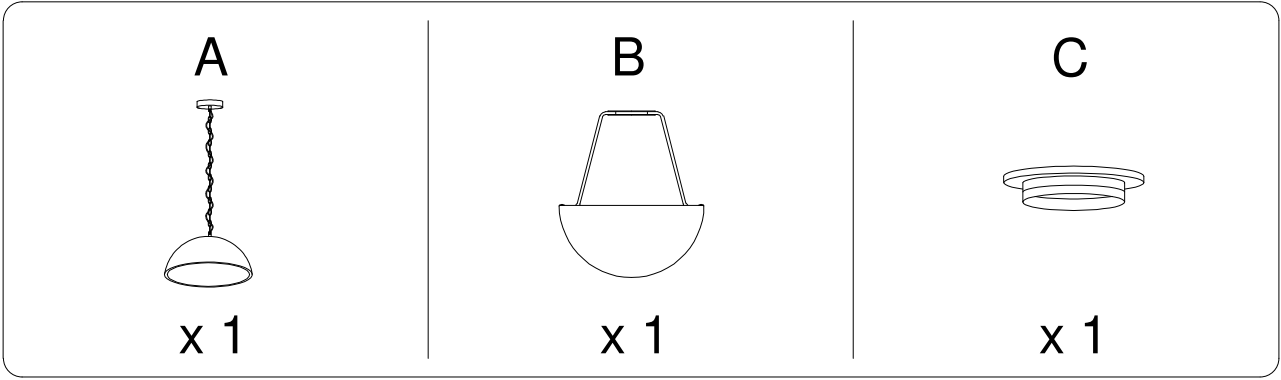

**A**

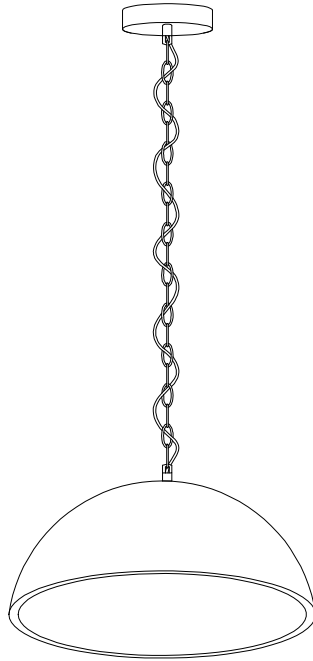

**C**



**B**

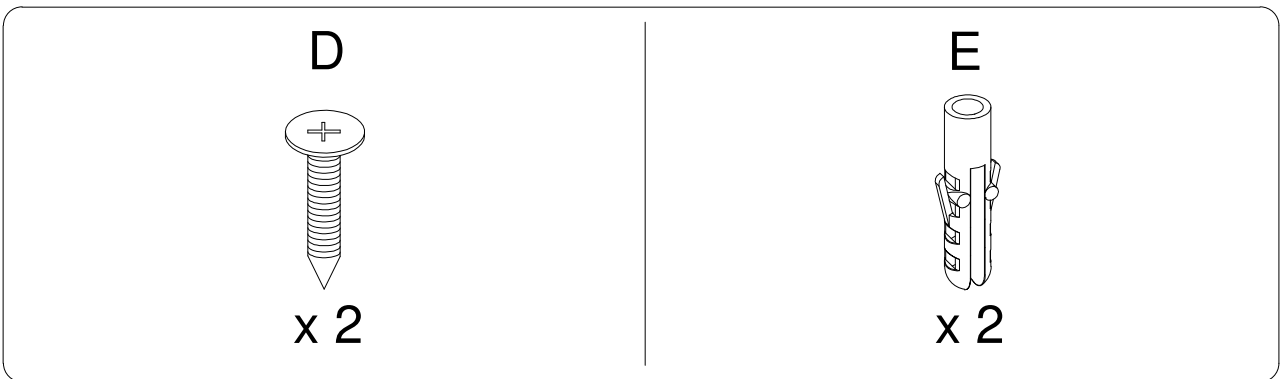
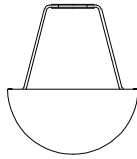

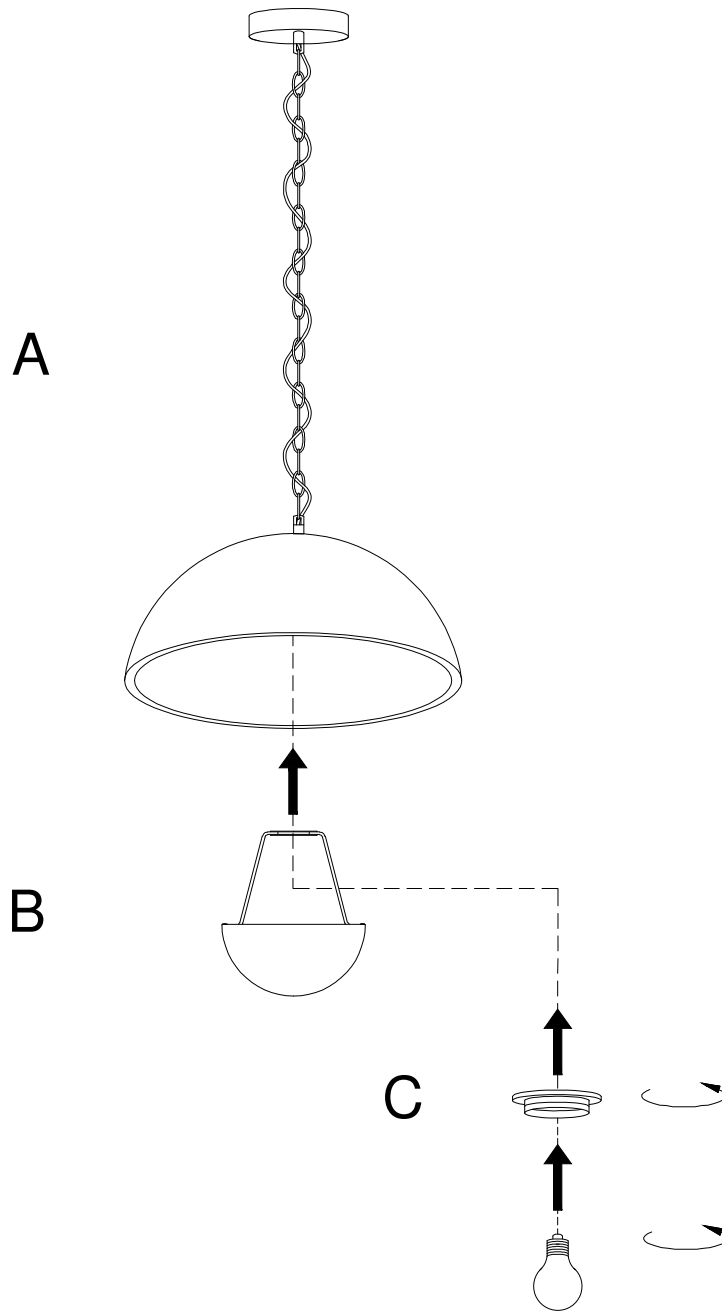
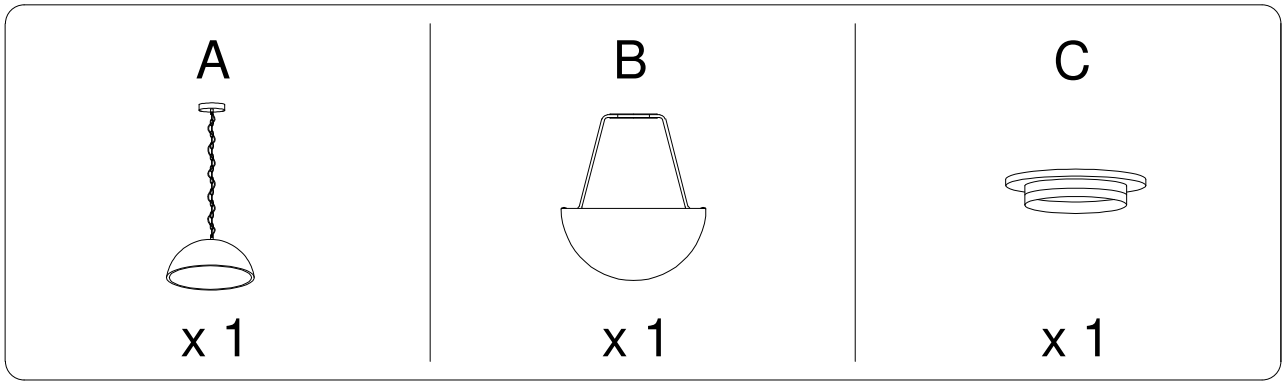

1

A



x 1

D



x 2

E



x 2

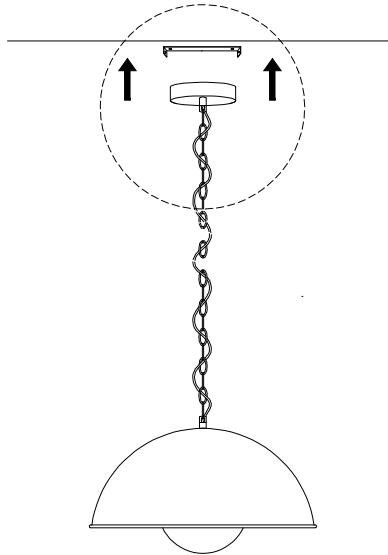

1a

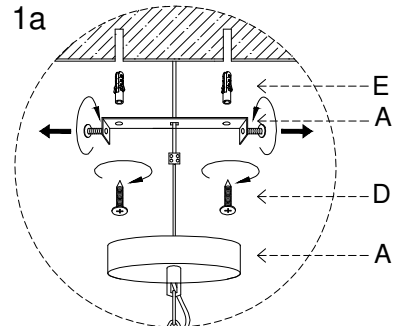

1b

