

1/4

A

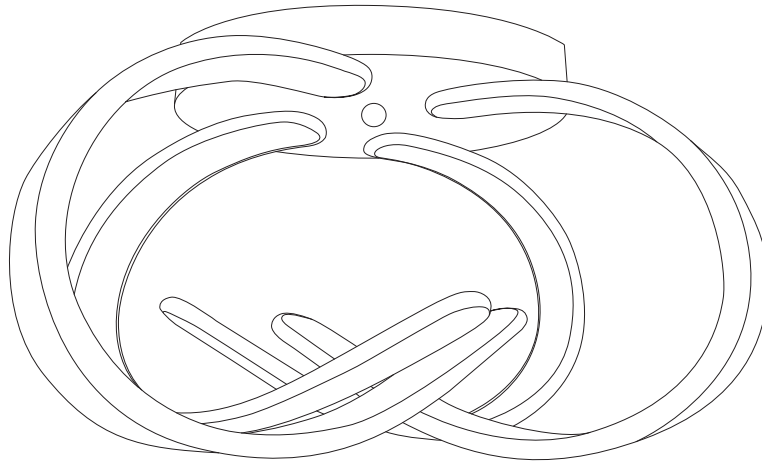

A

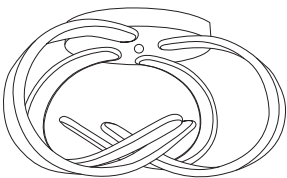

x 1

B

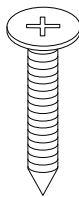

x 2

C

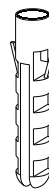

x 2

1





A

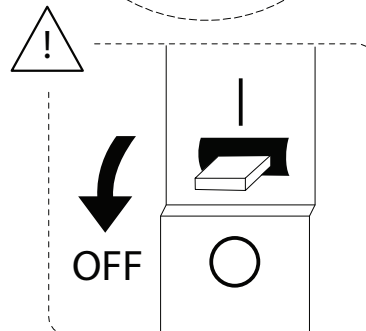
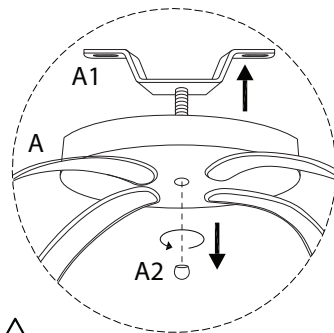
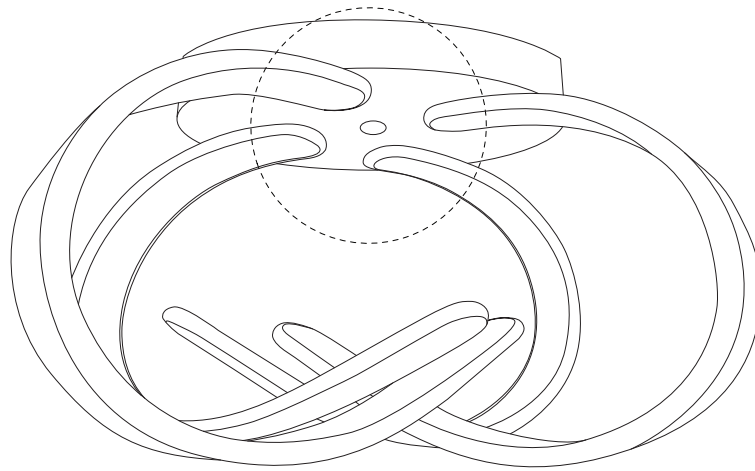

x 1

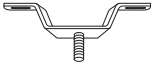

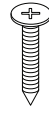
2

<p>A1</p>  <p>x 1</p>	<p>A2</p>  <p>x 1</p>	<p>B</p>  <p>x 2</p>	<p>C</p>  <p>x 2</p>
--	--	--	---

