

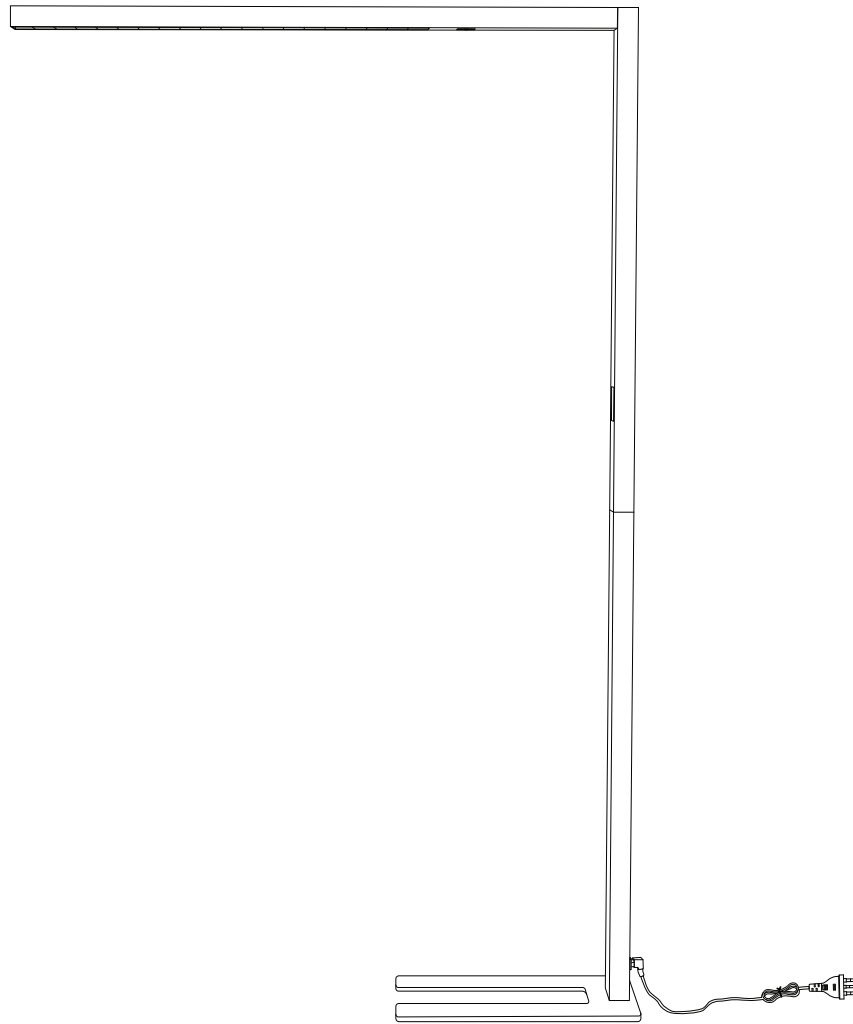

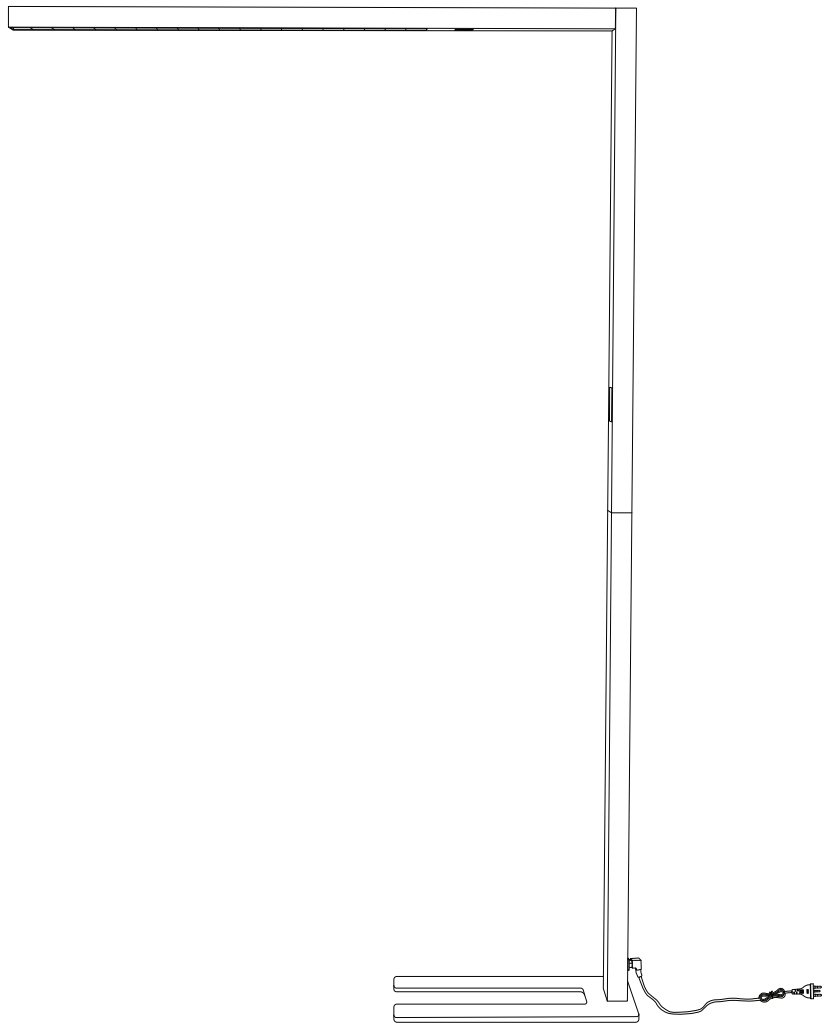

MENSA

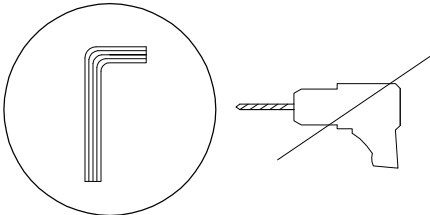



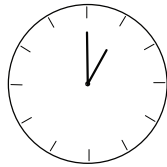
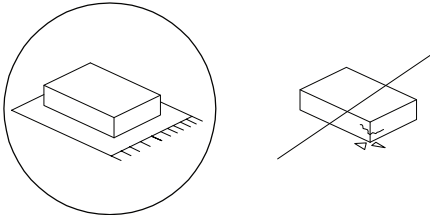

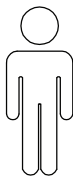



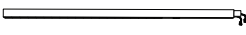

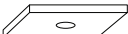

60'

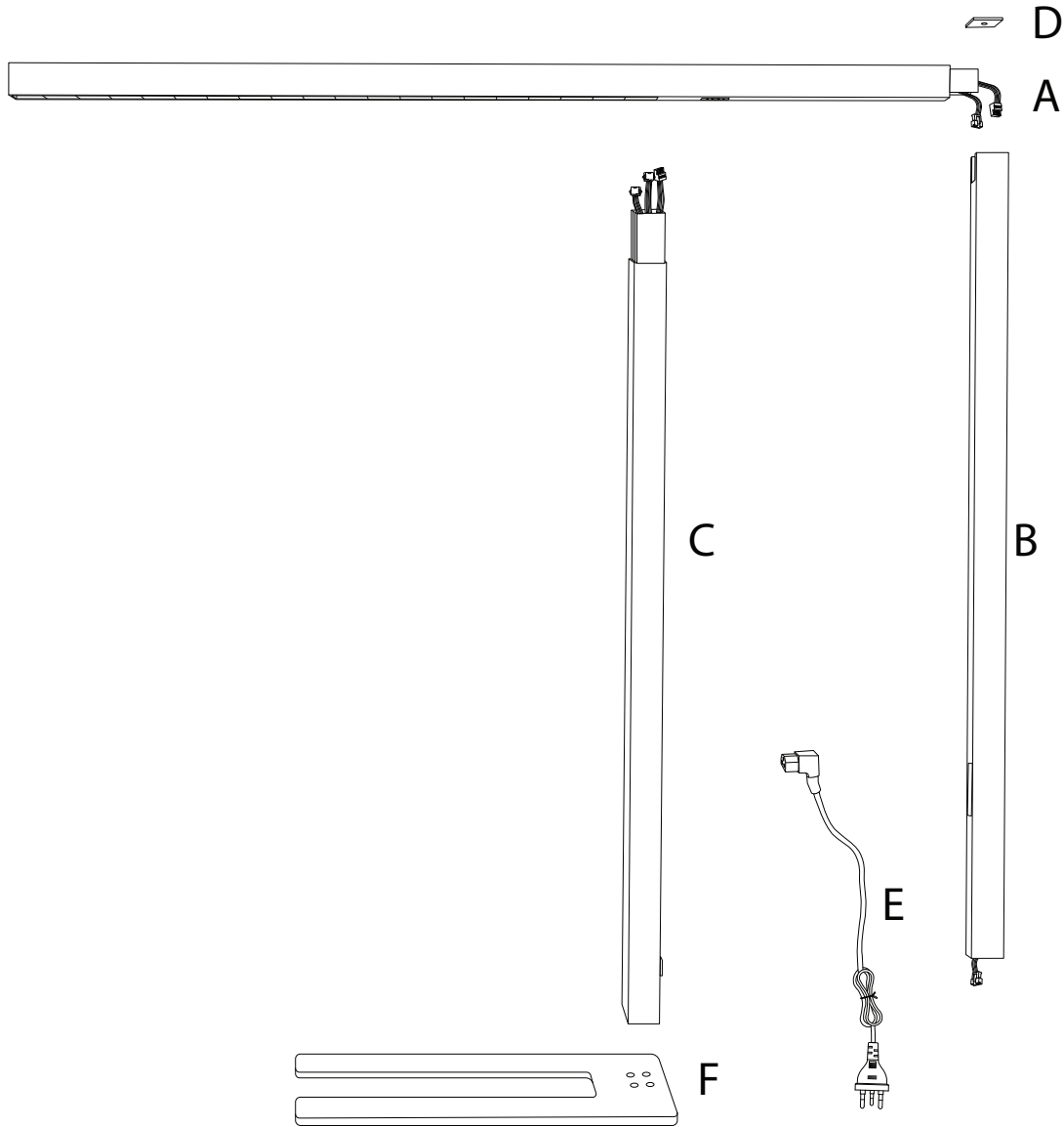
2

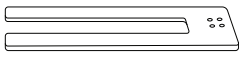
A	B	C	D	E
				
x 1	x 1	x 1	x 1	x 1

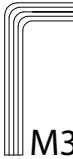

F	1	2	3	4
	 M4 x 20	 M4 x 14	 M3	 M2.5
x 1	x 8	x 3	x 1	x 1

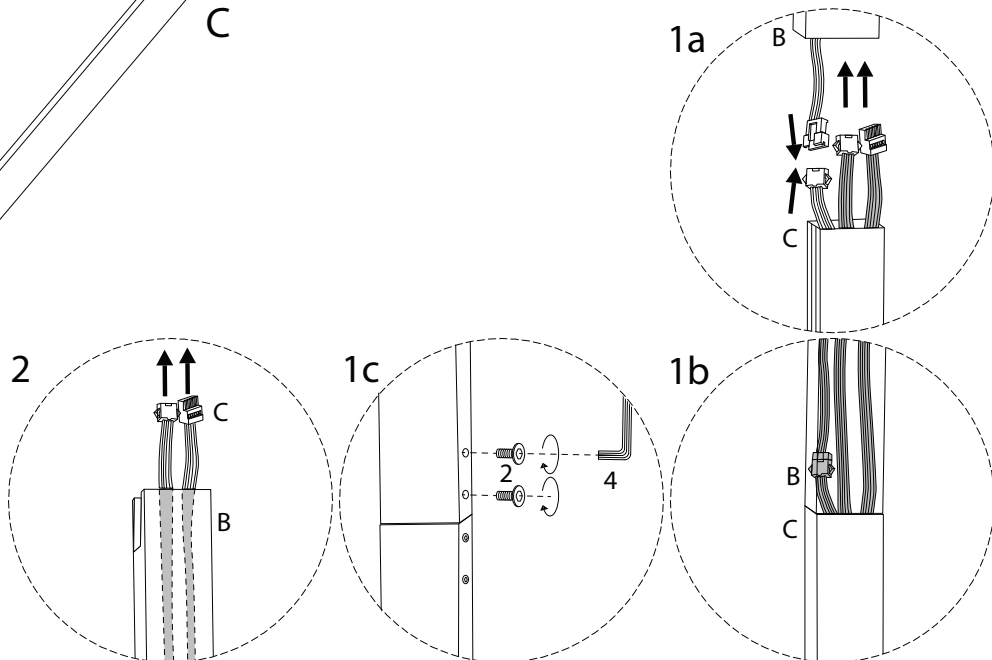
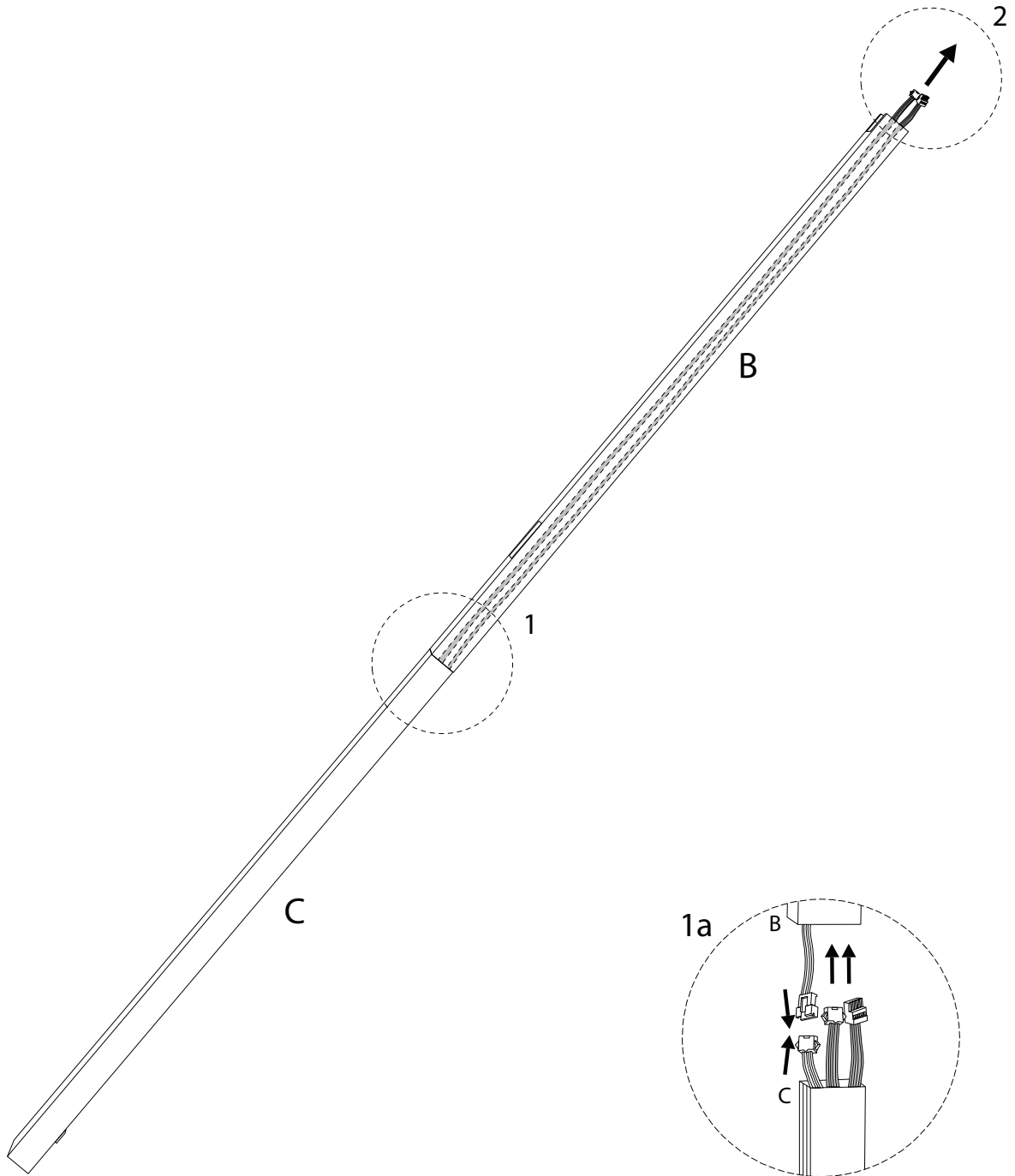
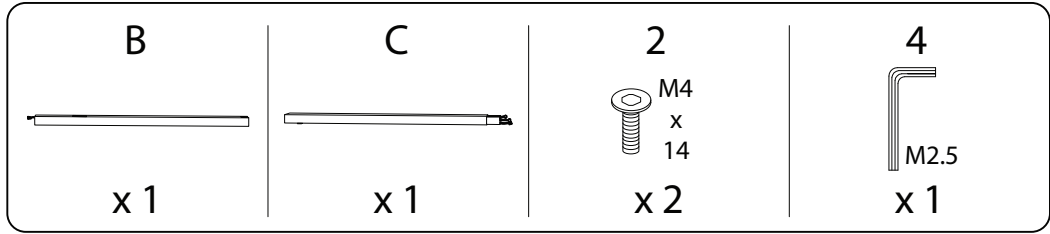

1

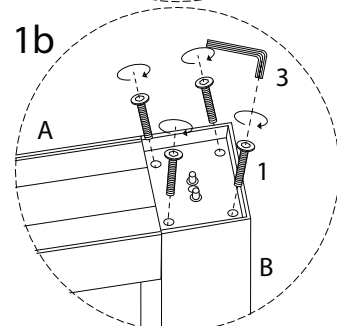
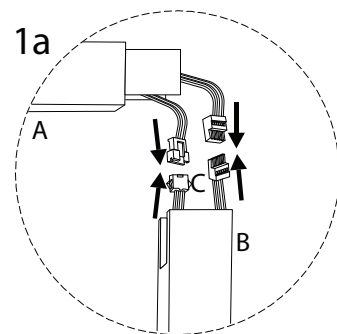
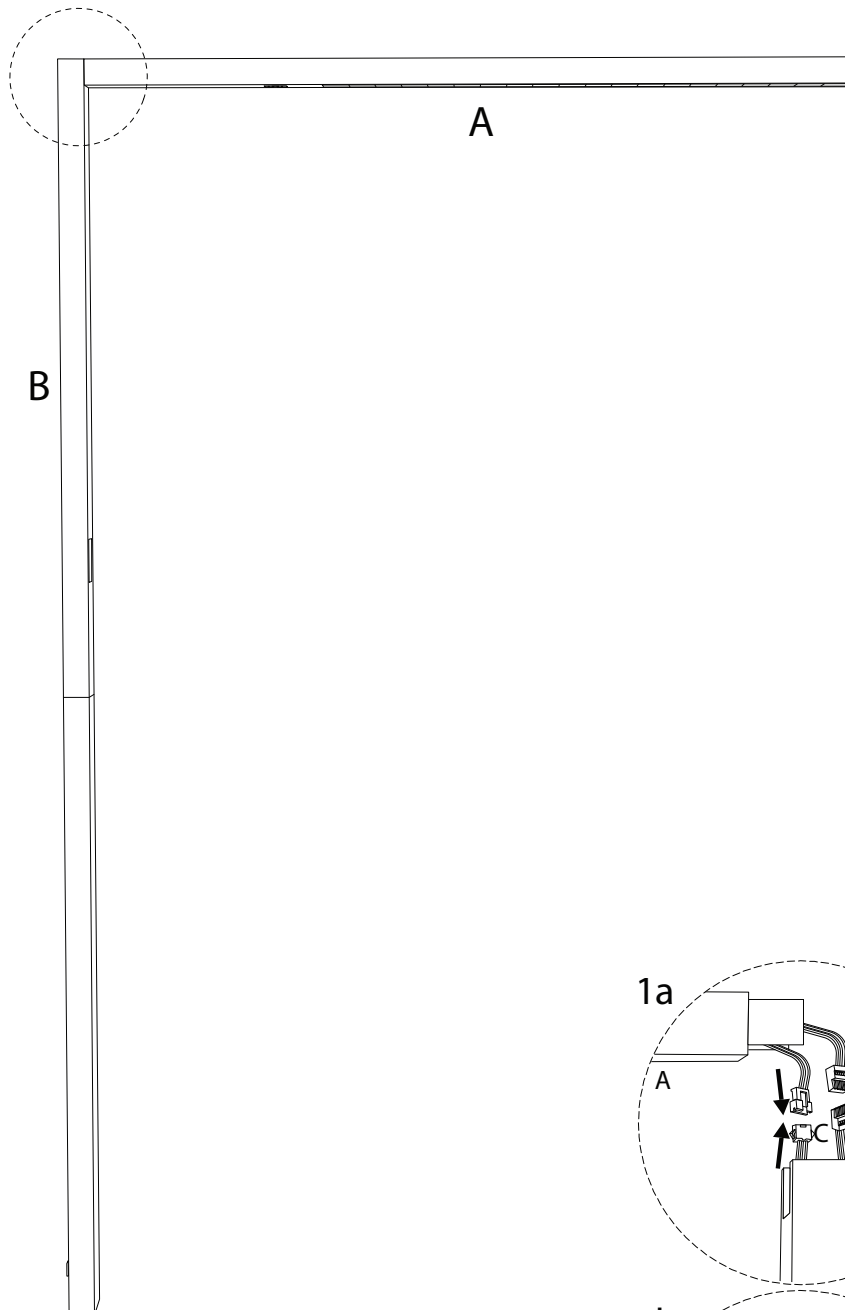
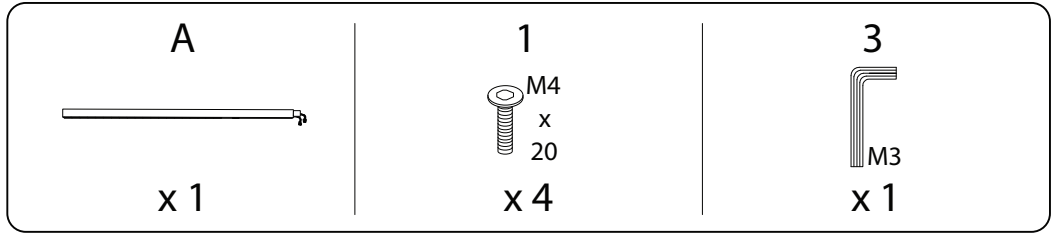

2



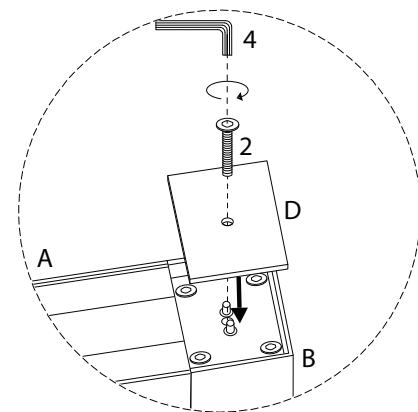
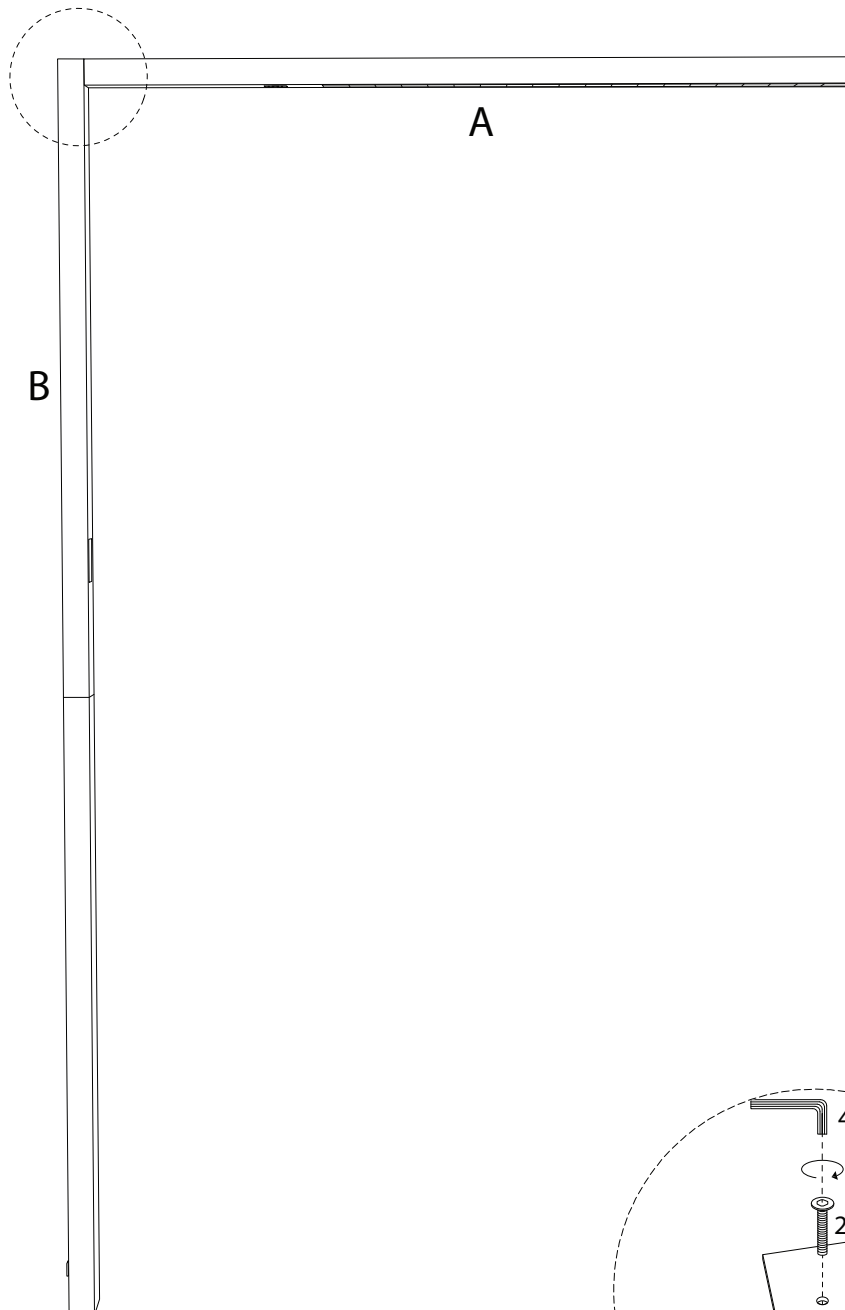

3

<p>D</p>  <p>x 1</p>	<p>2</p>  <p>M4 x 14</p> <p>x 1</p>	<p>4</p>  <p>M2.5</p> <p>x 1</p>
---	--	---

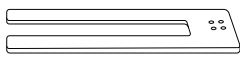

4

<p>F</p>  <p>x 1</p>	<p>1</p>  <p>M4 x 20</p> <p>x 4</p>	<p>3</p>  <p>M3</p> <p>x 1</p>
---	--	---

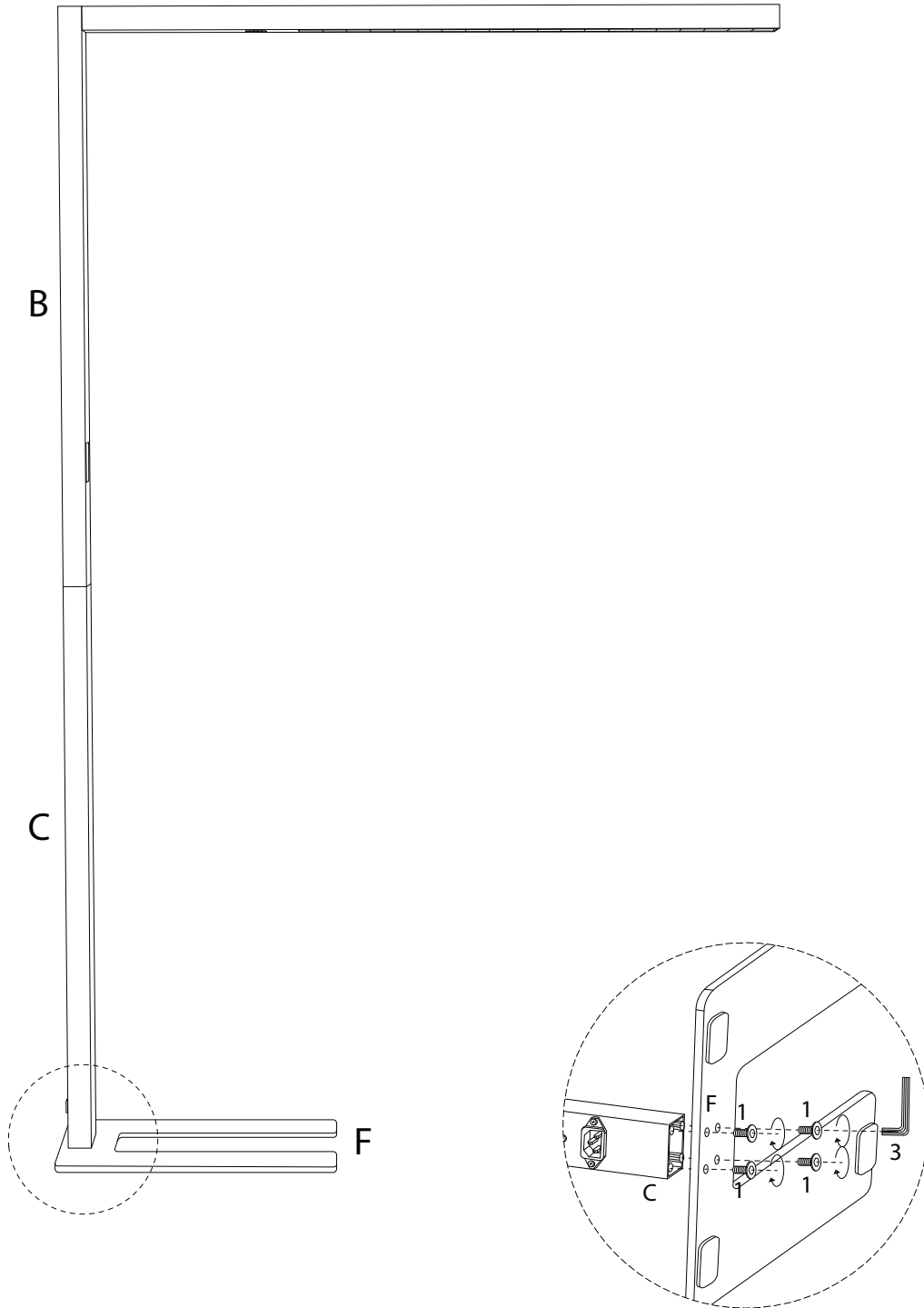

5

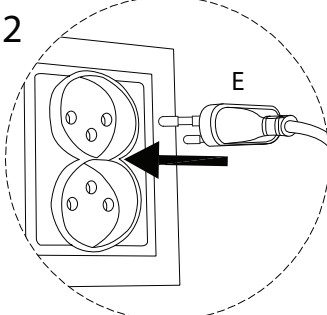
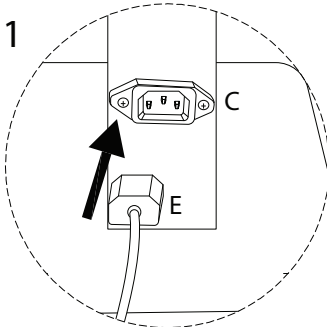
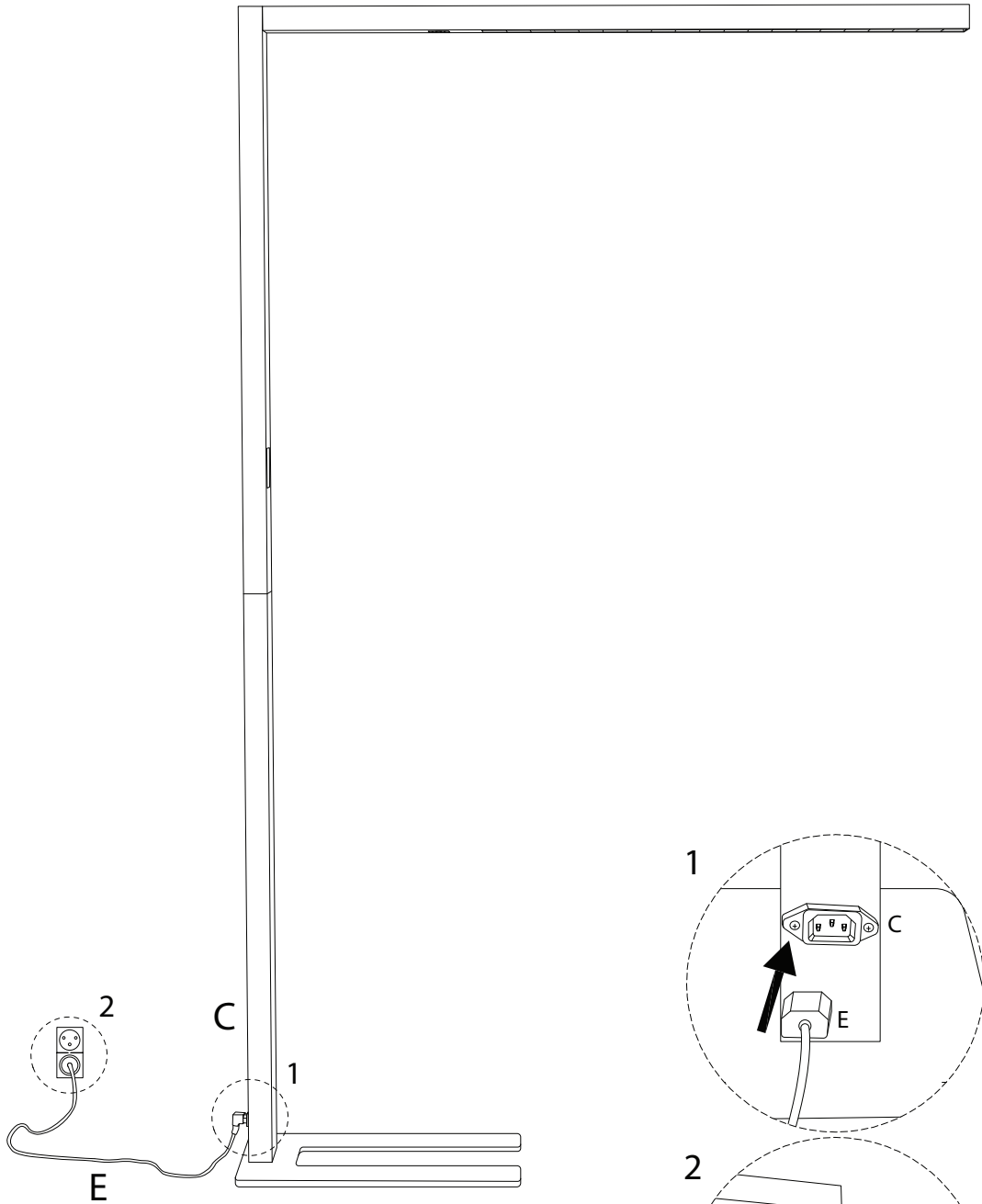
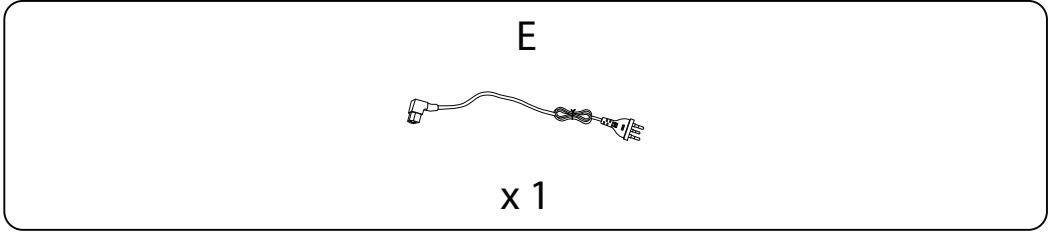

!

