



www.MLMEBLE.pl

GB D CZ SK RUS LT  
assembly instructions / montageanleitung / montážní návod / montážny návod / инструкции по монтажу / surinkimo instrukcija







## INSTRUKCJA MONTAŻU

### CASTEL 16

↑24→138↗21

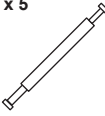
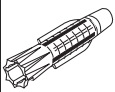

akcesoria / accessories / zubehör / příslušenství / príslušenstvo / аксесуары / furnitūra :

x 5  KK 8/60	x 10  BMD	x 5  MD2 L76	x 3  KR Ø10	x 3  ZAN	x 3  KT 6,4/70
---	--	--	--	---	--

do montażu potrzebne są:  
are needed for assembly:  
sind erforderlich für die montage:  
jsou potřebné pro montáž:  
sú potrebné pre montáž:  
которые необходимы для сборки:  
Surinkimui reikės:

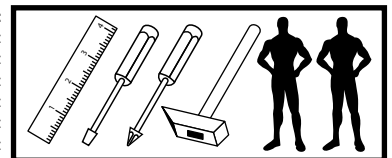

**! UWAGA !** - w pierwszej kolejności wbijamy akcesoria „KK” i „MD” w blaty oraz boki.  
**WARNING!** - The first accessory sticks "KK" and "MD" in the tops and sides.  
**WARNUNG!** - Die erste Accessoire-Sticks "KK" und "MD" in den Spitzen und an den Seiten.  
**POZOR!** - První příslušenství holí "KK" a "MD" v korunách a boky.  
**POZOR!** - Prvé príslušenstvo palíc "KK" a "MD" v korunách a boky.  
**ВНИМАНИЕ!** - Первый аксессуаров палочки "KK" и "MD" по вершинам и по бокам.  
**DĚMESIO!** - Pirmiausiai furnitūrą KK ir MD įkalame į stalviršį ir šonus.

Nr/No	CODE	Szt/Qty
1	Castel16 01	1
2	Castel16 02	1
3	Castel16 03	1

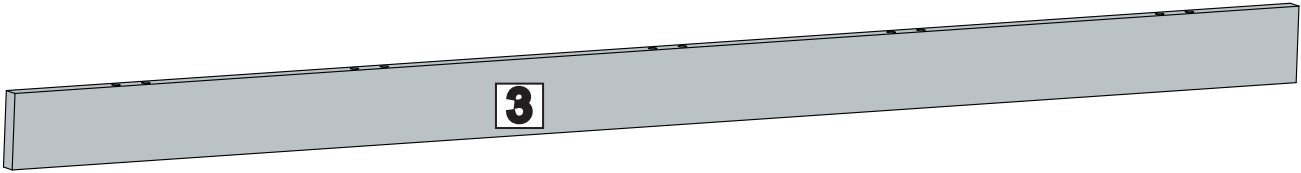
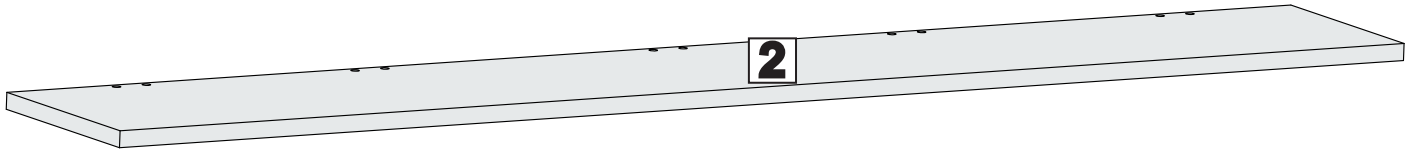
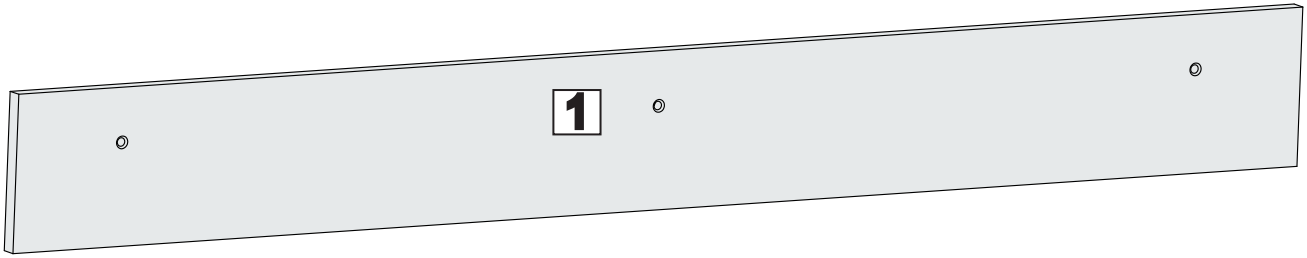

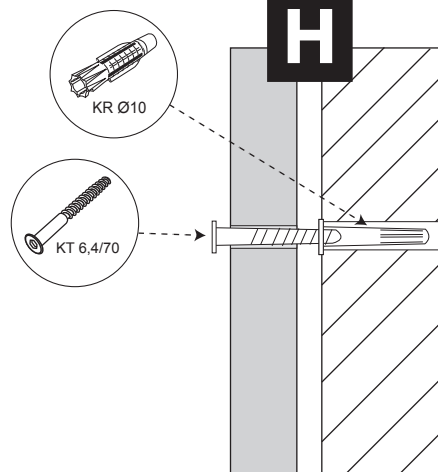
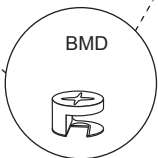
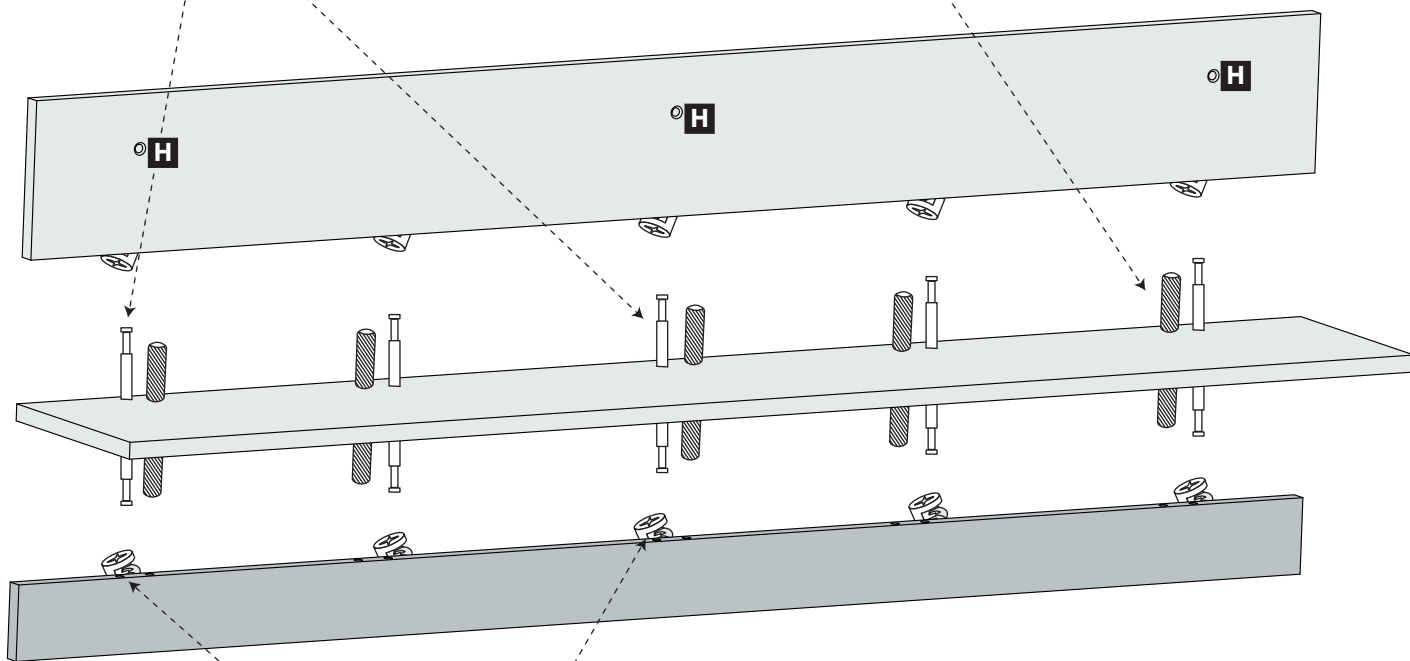
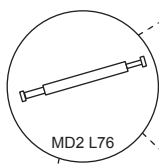
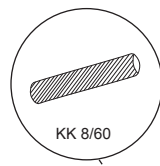
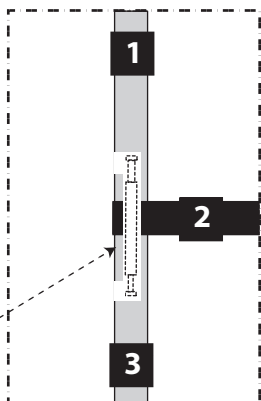
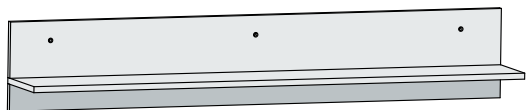

**!** UWAGA ! - Mocowanie do ściany.  
**WARNING!** - Attaching to the wall.  
**WARNUNG!** - Anbringen an der Wand.  
**POZOR!** - Připevnění na stěnu.  
**POZOR!** - Připevnenie na stěnu.  
**ВНИМАНИЕ!** - Крепление к стене  
**DĚMESIO!** - Tvirtinimas prie sienos.