

OVIO SZ2D

PL> INSTRUKCJA MONTAŻU
D >MONTAGEANLEITUNG
GB>ASSEMBLY INSTRUCTIONS

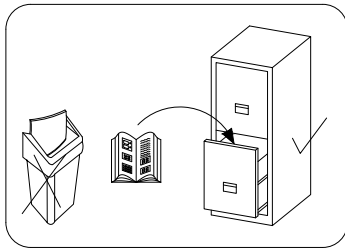

Czas montażu
 Montagezeit
 Time to assemble

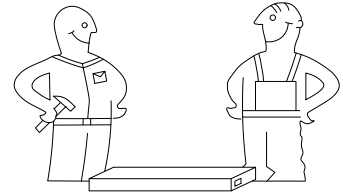
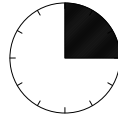

1 hours
 1 zeit
 1 godz.

Tools required narzędzia wymagane Werkzeuge erforderlich

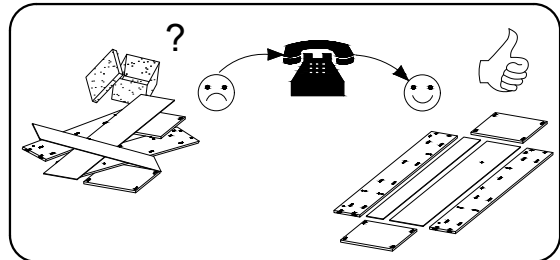
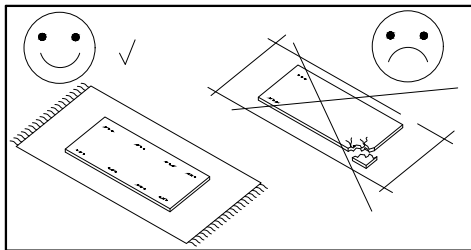
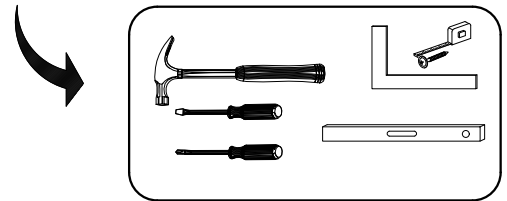

Uwaga / Achtung / Caution

PL>Czyszczenie należy wykonać wyłącznie za pomocą ściereczki lub lekko nawilżonego ręcznika.
 Nie stosować środków czyszczących do szorowania.

Szanowny kliencie, jeśli podczas montażu stwierdzisz uszkodzenie lub brak części, proszę podaj jej kod alfanumeryczny lub zaznacz ją na instrukcji montażu i prześlij wraz z protokołem reklamacyjnym

D >Bitte nur mit einem Staubtuch oder leicht feuchtem Lappen reinigen. Keine scheuerenden Putzmittel verwenden.

Sehr geehrter kunde, sollte ein teil fehlen oder beschädigt sein, kreuzen sie dies bitte deutlich auf der montageanleitung an und schicken sie die montageanleitung mit ein.

GB>Please only clean with a duster or a damp cloth. Do not use any abrasive cleaners.

Dear customer, should there be any piece missing or damaged, kindly mark this piece clearly on the attached assembly instructions and return them to us.

Karta serwisowa /Service Karte /Service card

AKCESORIA / ZUBEHÖR / ACCESSORIES

8.0x35 D 42	S 12	M3 4	A 22	B 22	3.5x16 H 14	I 10	L 6	"15" Z1 6	V2 32	
X 22	F 2	4.0X30 G 2	V 16	N2 2	V1 16	O 3	K 1	T1 8	L-370 1	T1 8

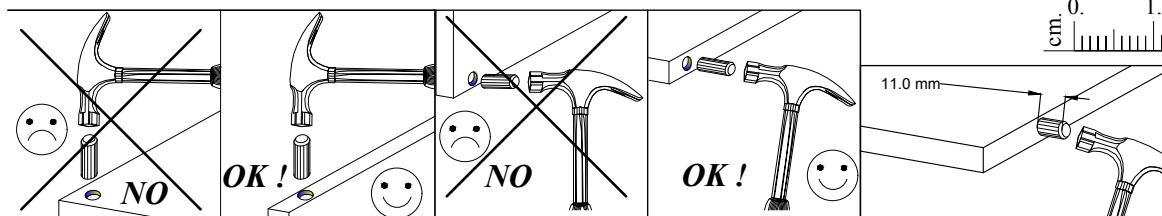

No.	Pcs.	L	W	D	Pac
1	1	800	520	16	1/1
2	1	800	520	16	1/1
3	1	1873	520	16	1/1
4	1	1873	520	16	1/1
5	1	1873	480	16	1/1
6	3	460	376	16	1/1
7	2	480	376	16	1/1
8	2	1887	391	3	1/1
9	1	767	60	16	1/1
10	1	767	100	16	1/1
11	2	1840	381	16	1/1
12	1	376	150	16	1/1

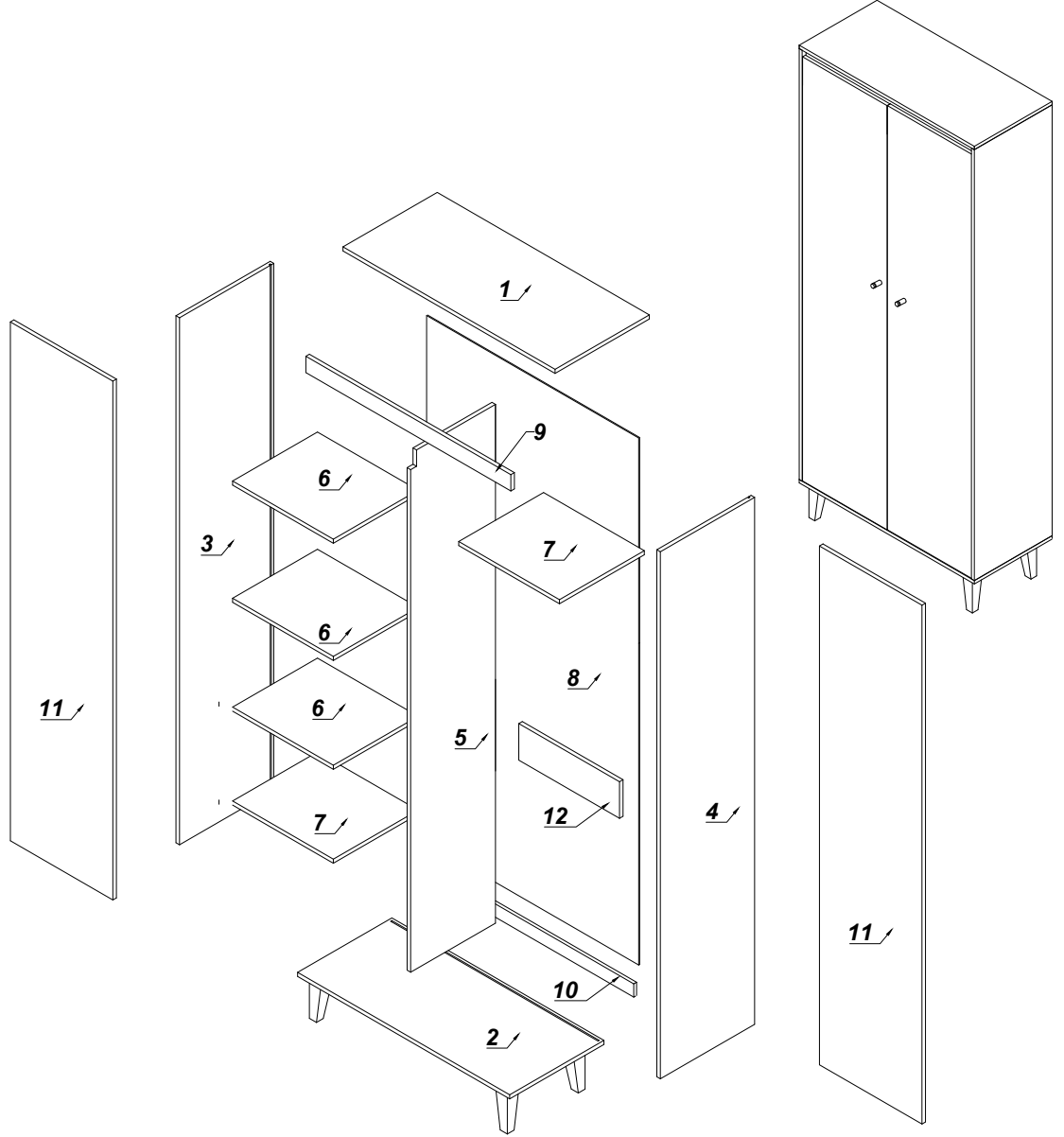

1

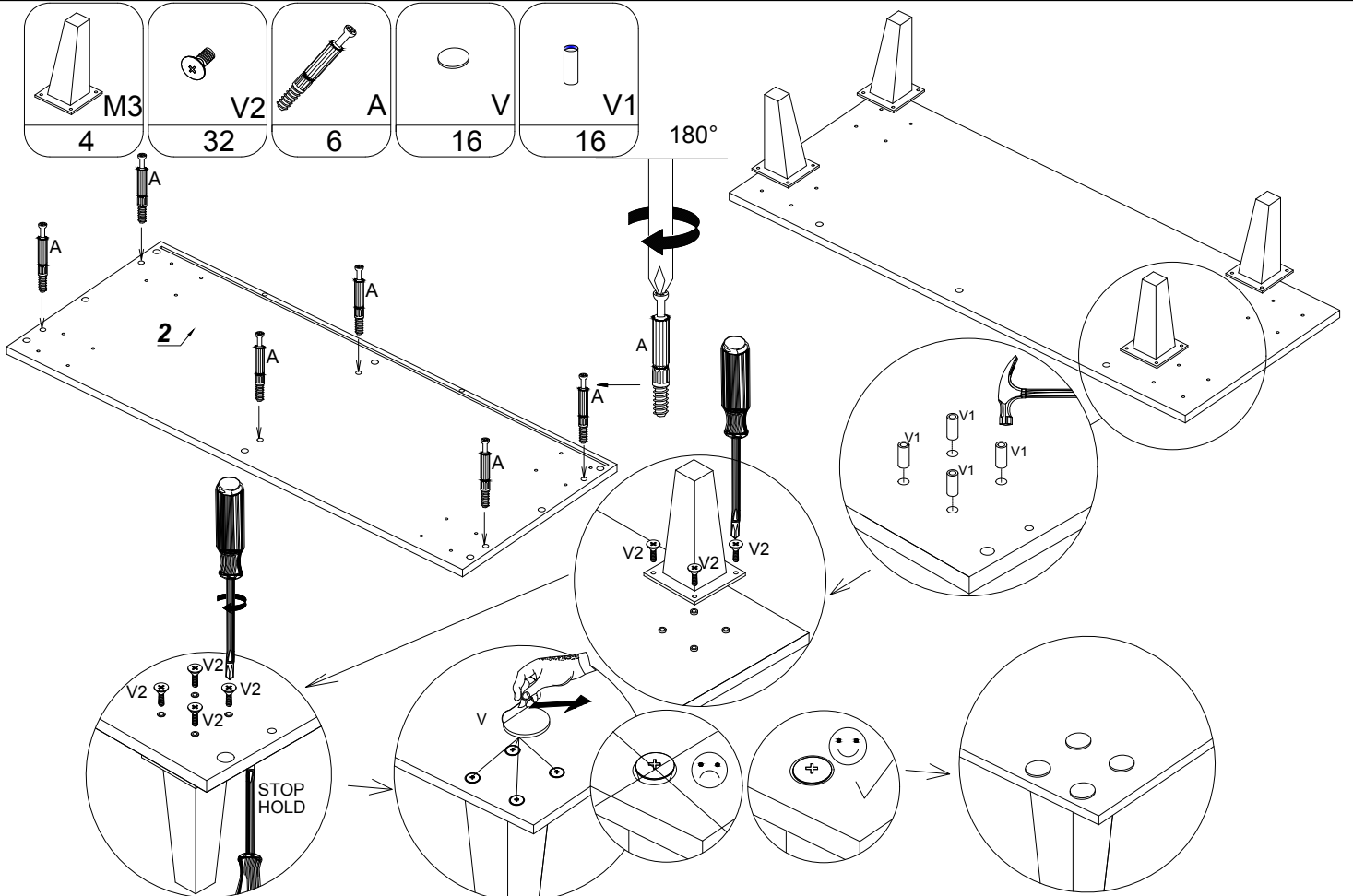

2

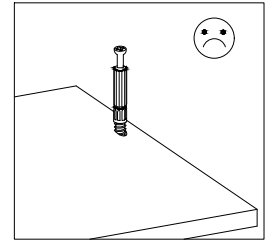
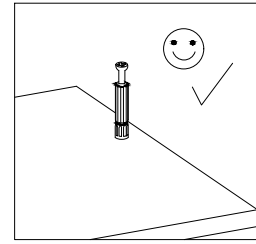
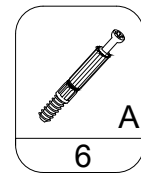
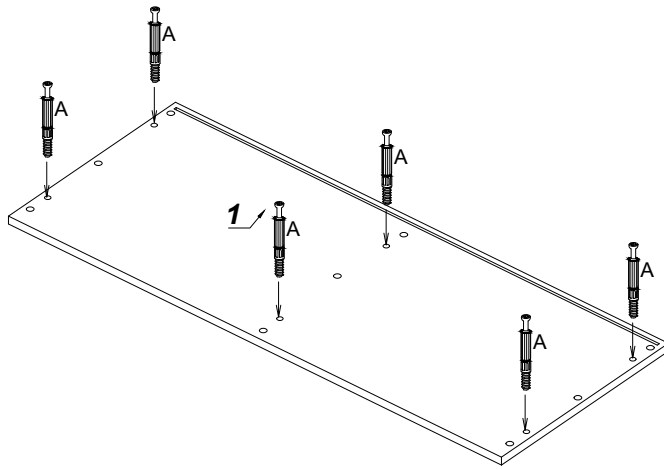

3

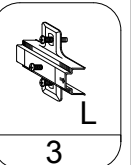
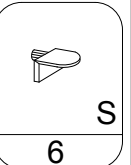
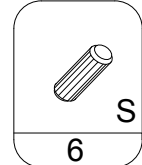
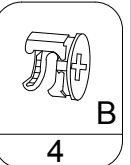
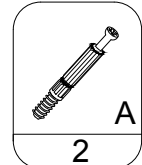
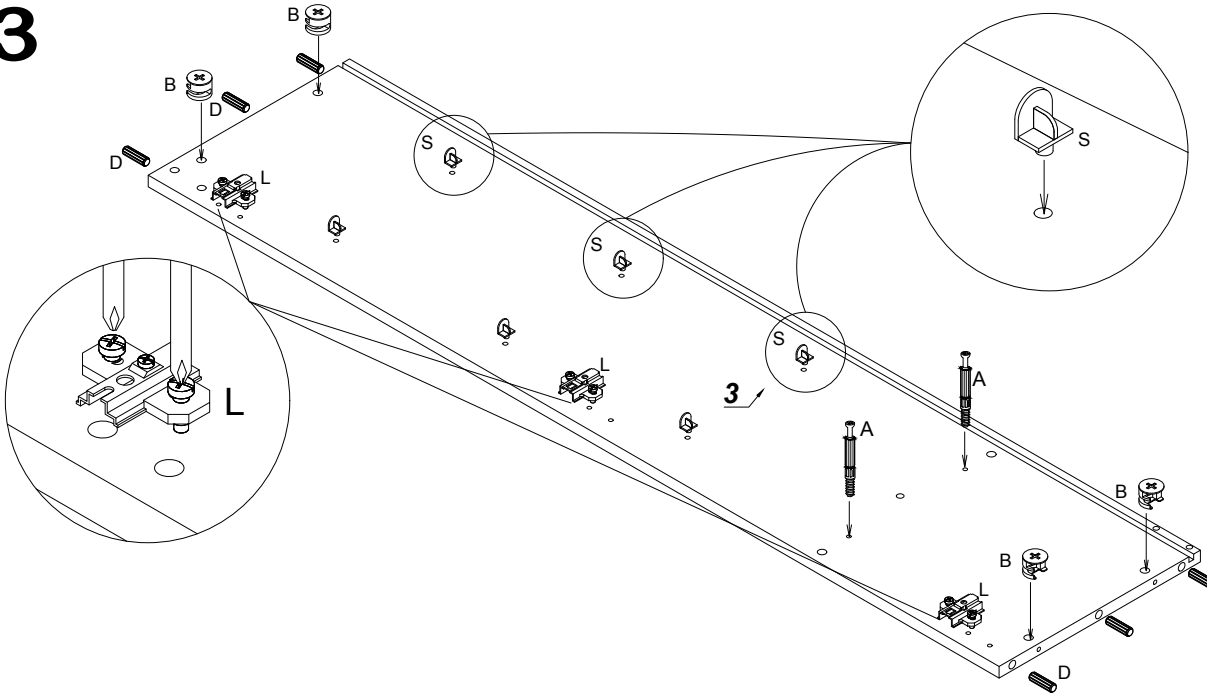

4

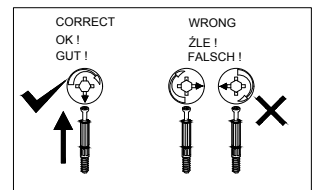
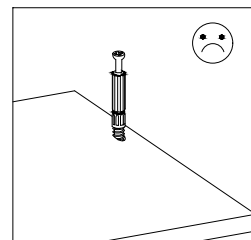
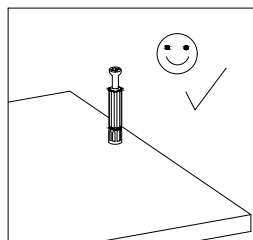
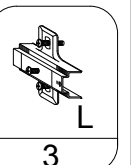
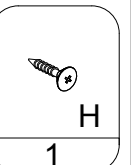
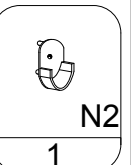
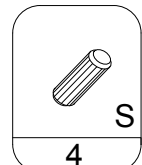
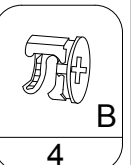
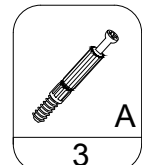
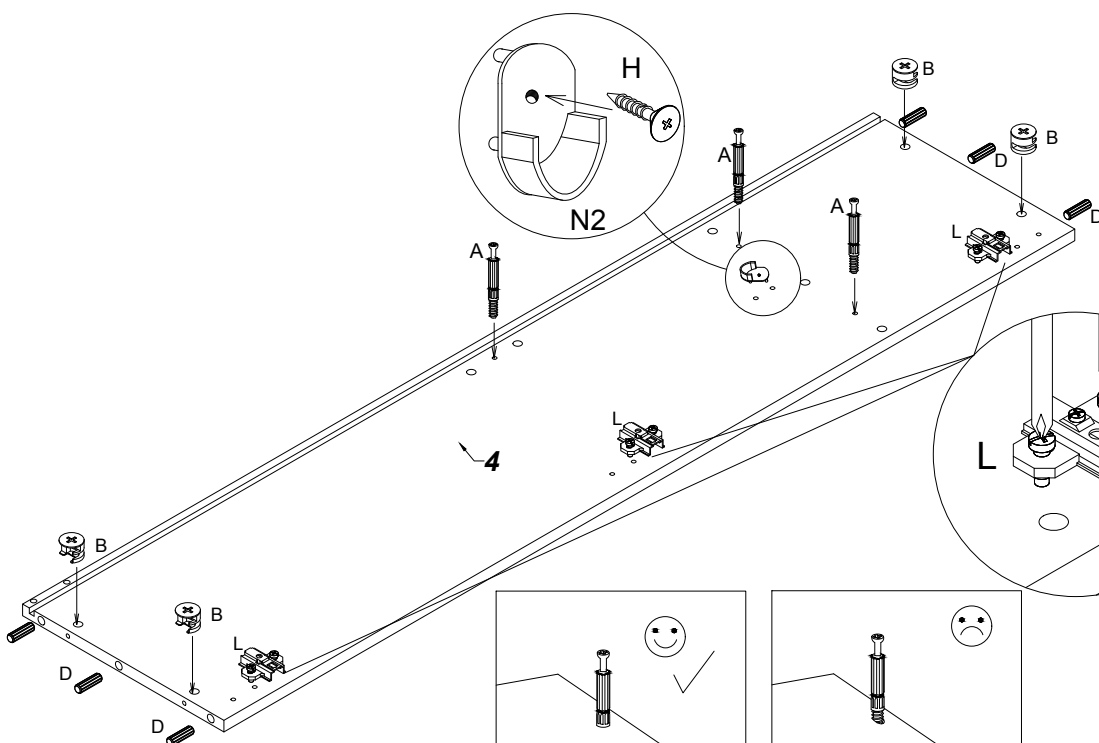

5

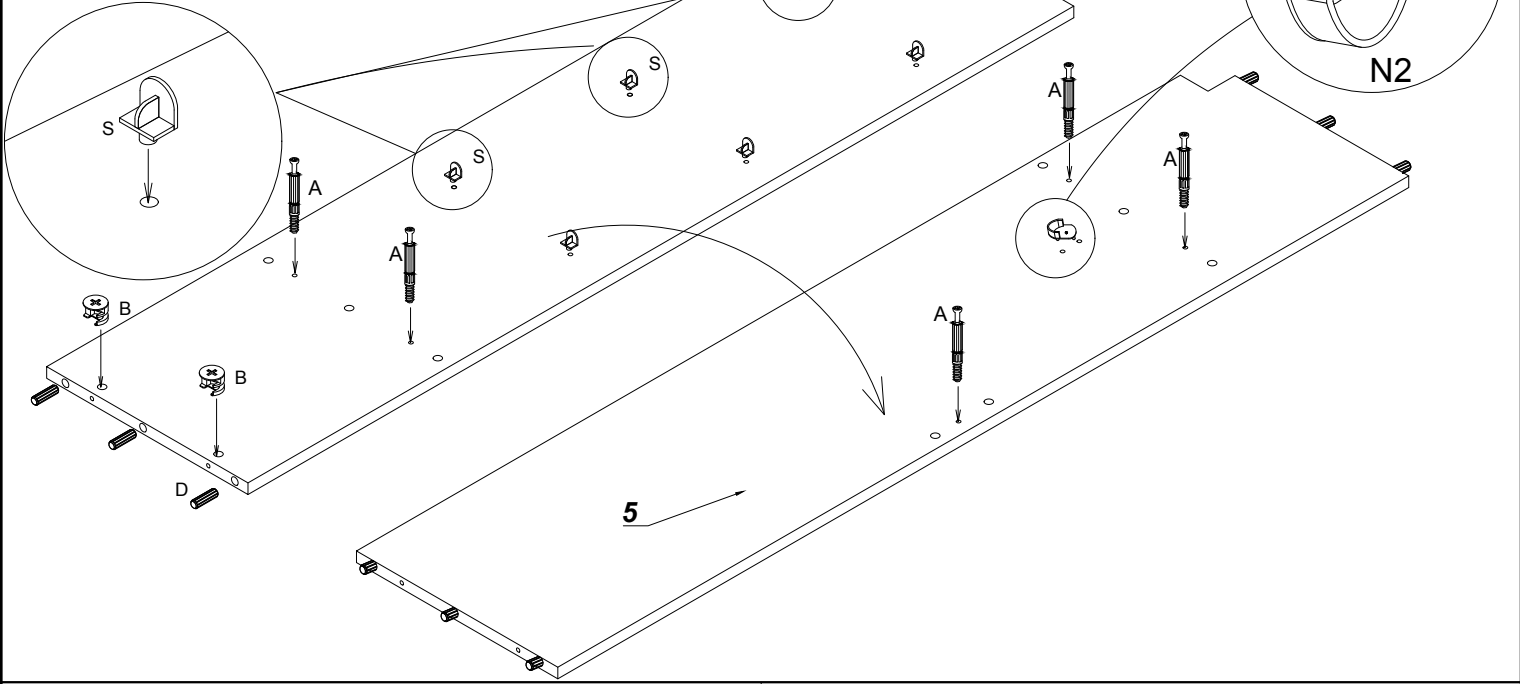
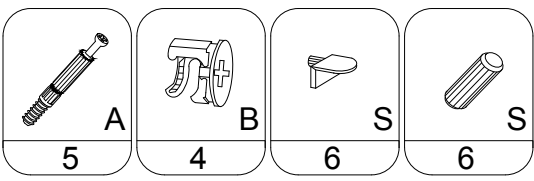

6

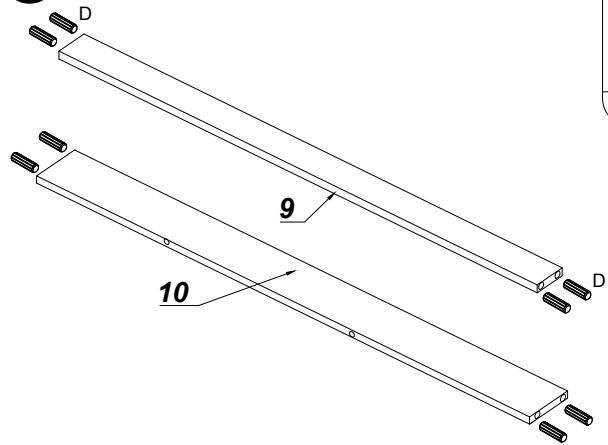
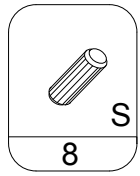

7

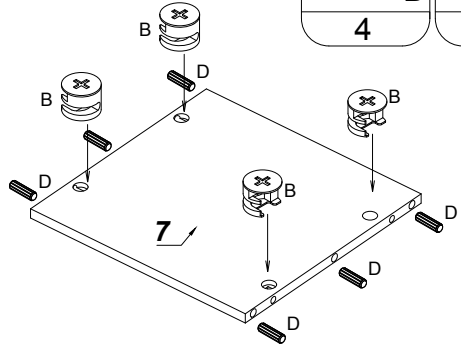
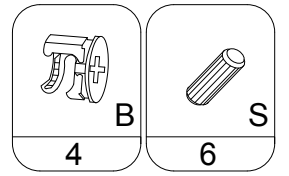

8

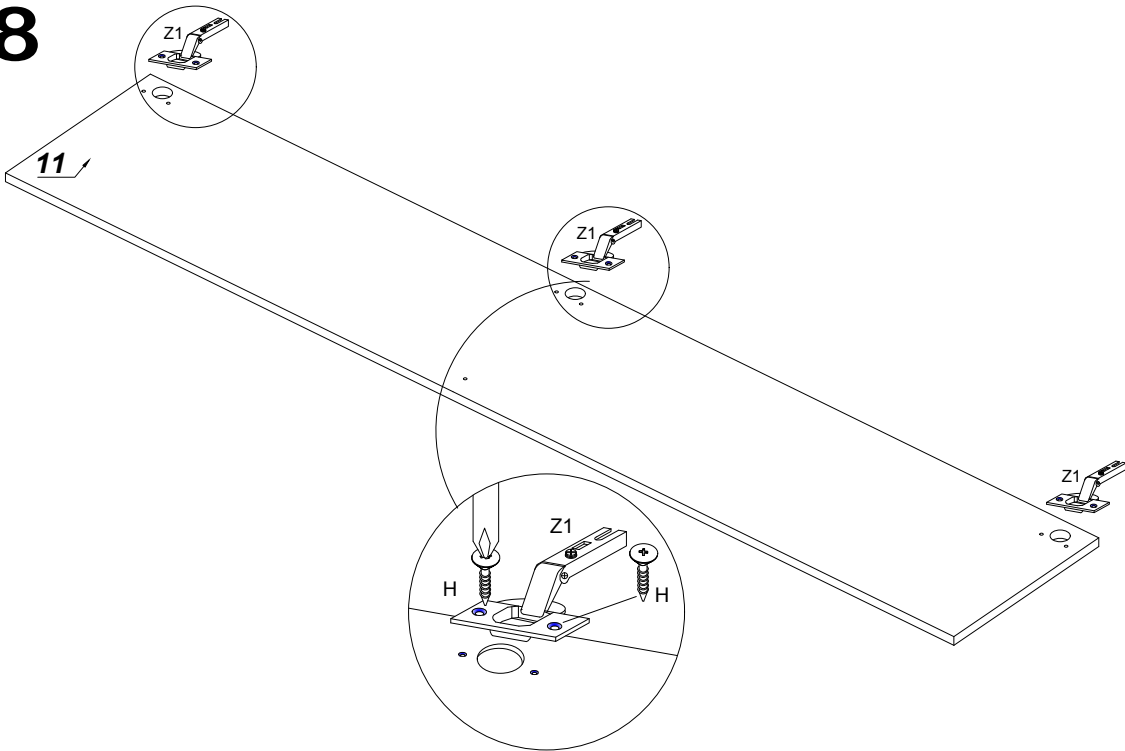
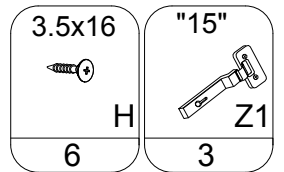

9

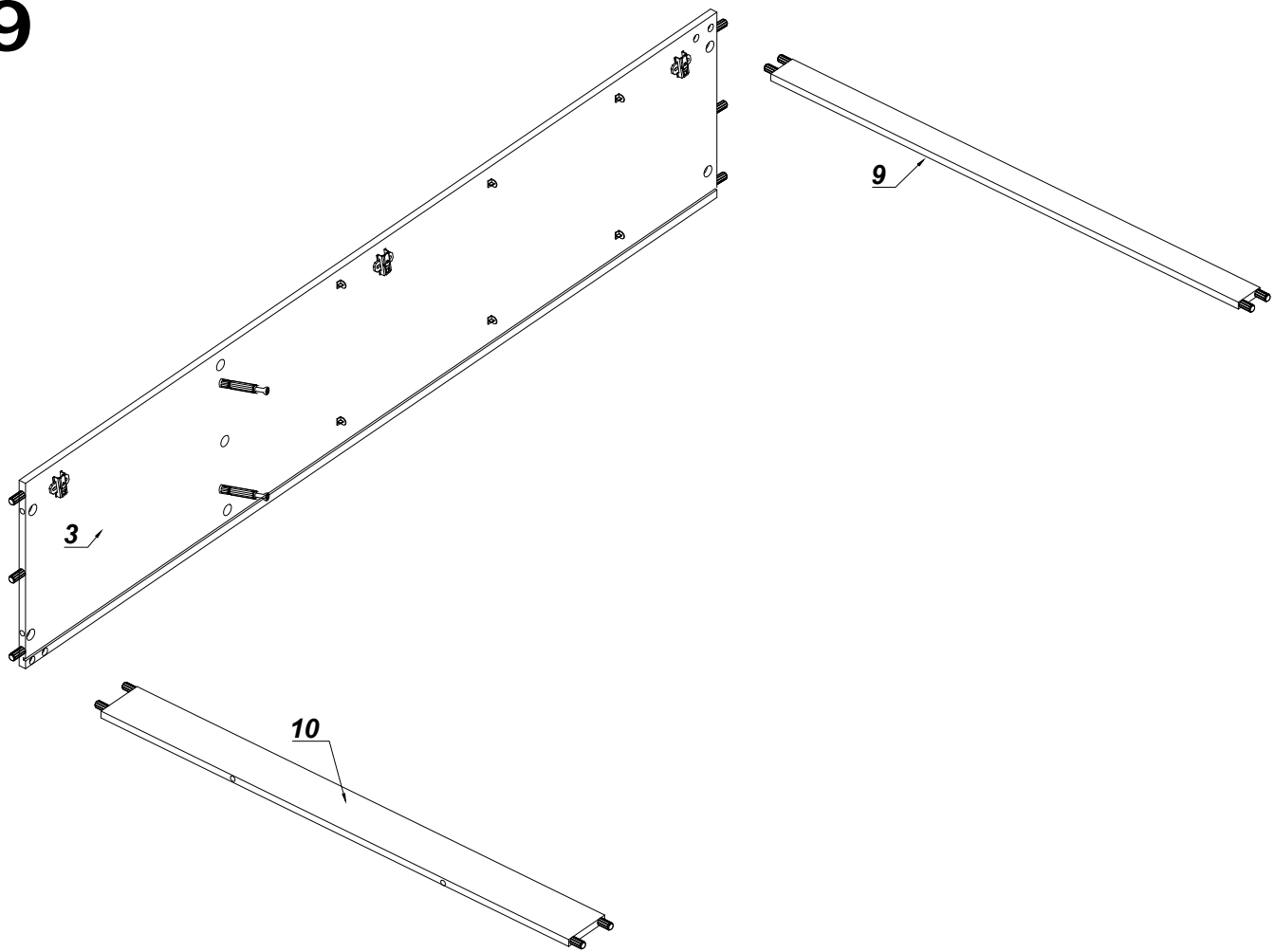

10

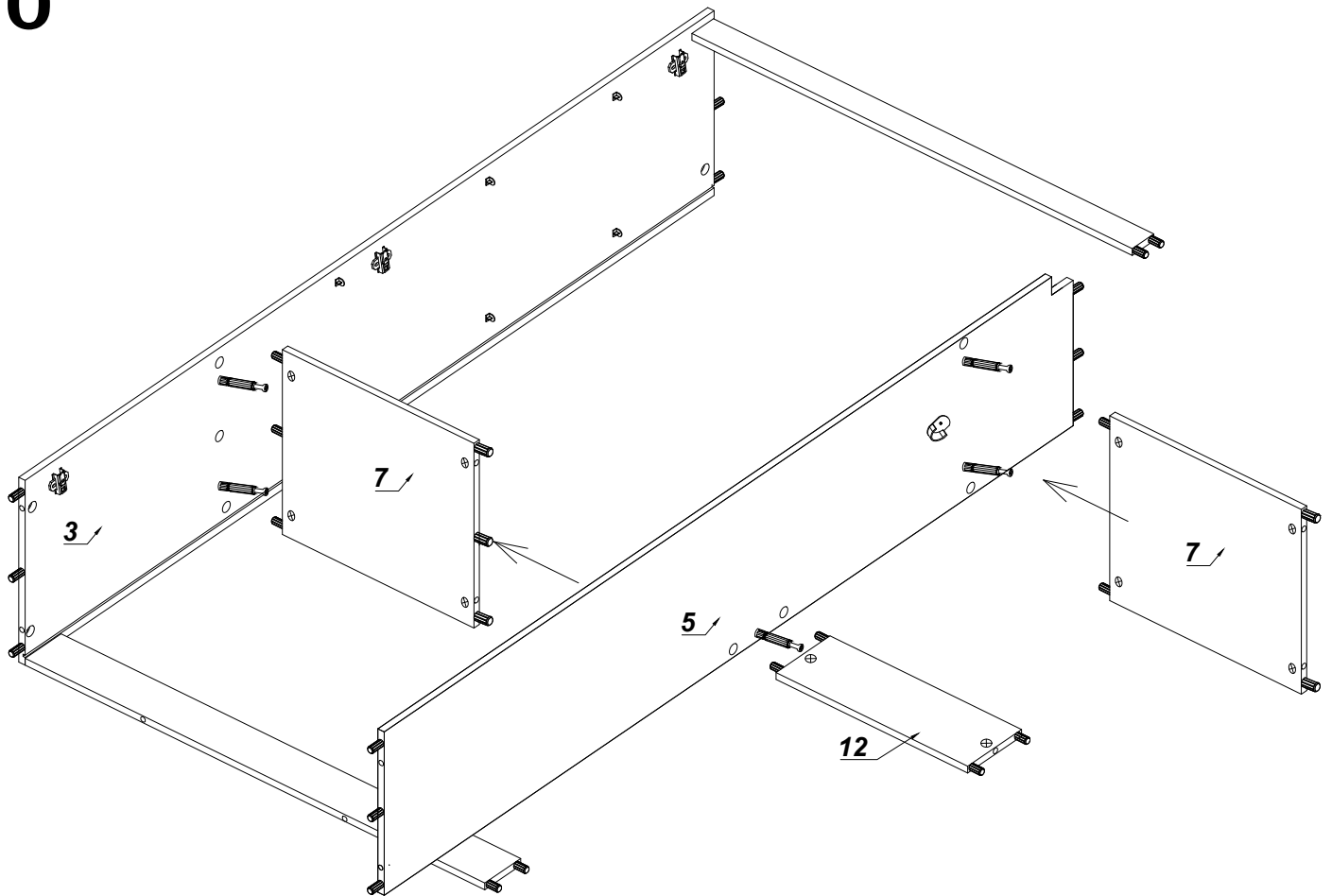

11

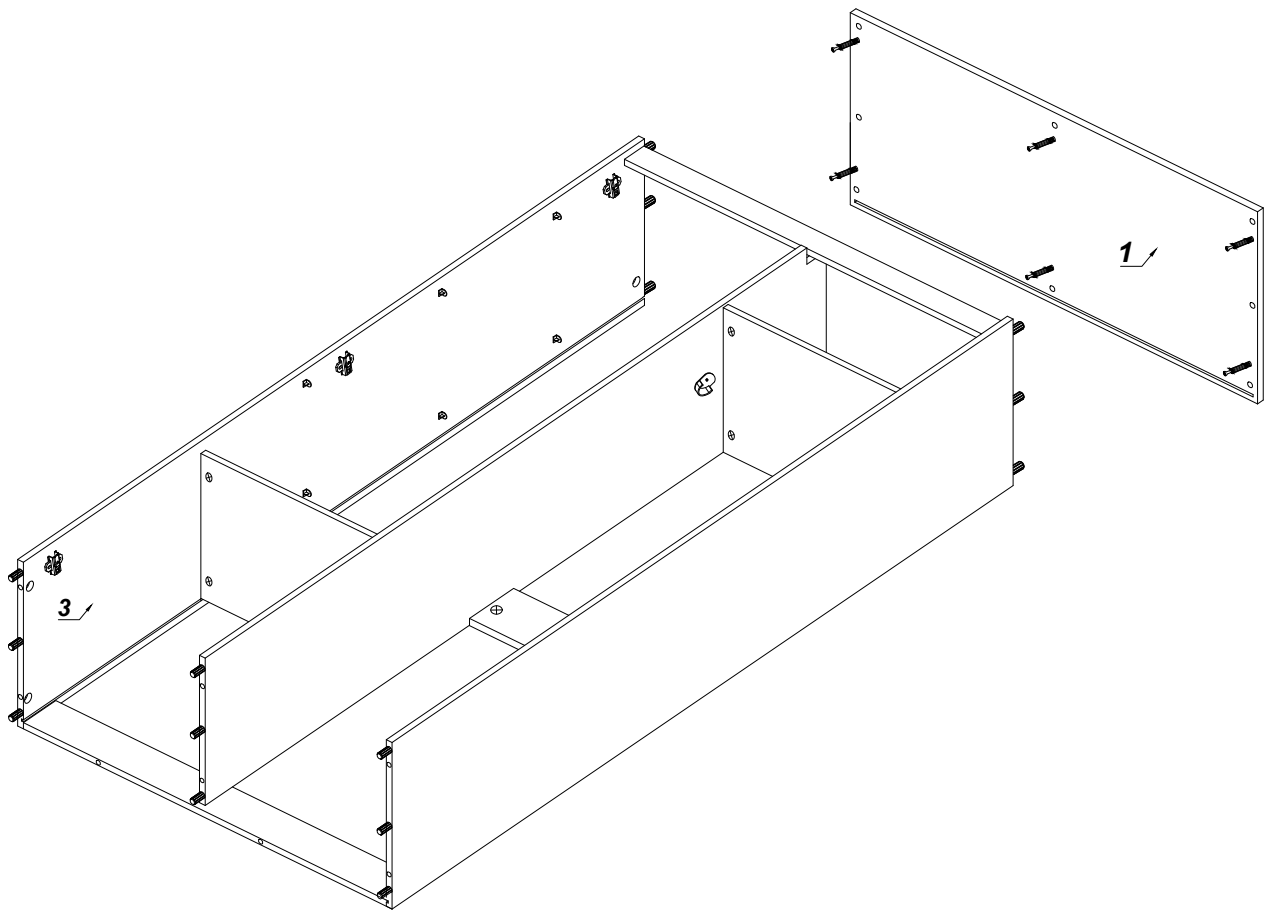

12

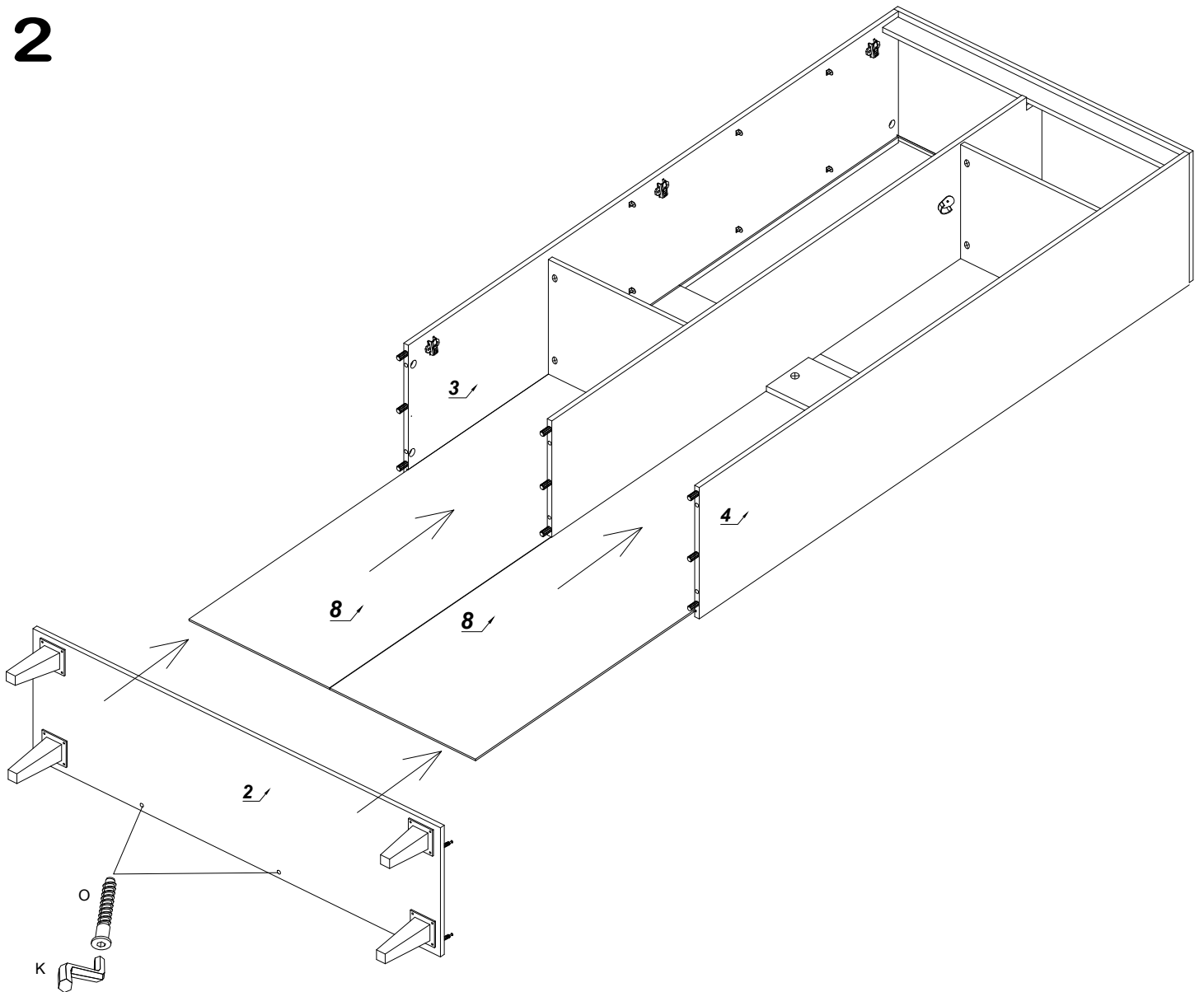

13

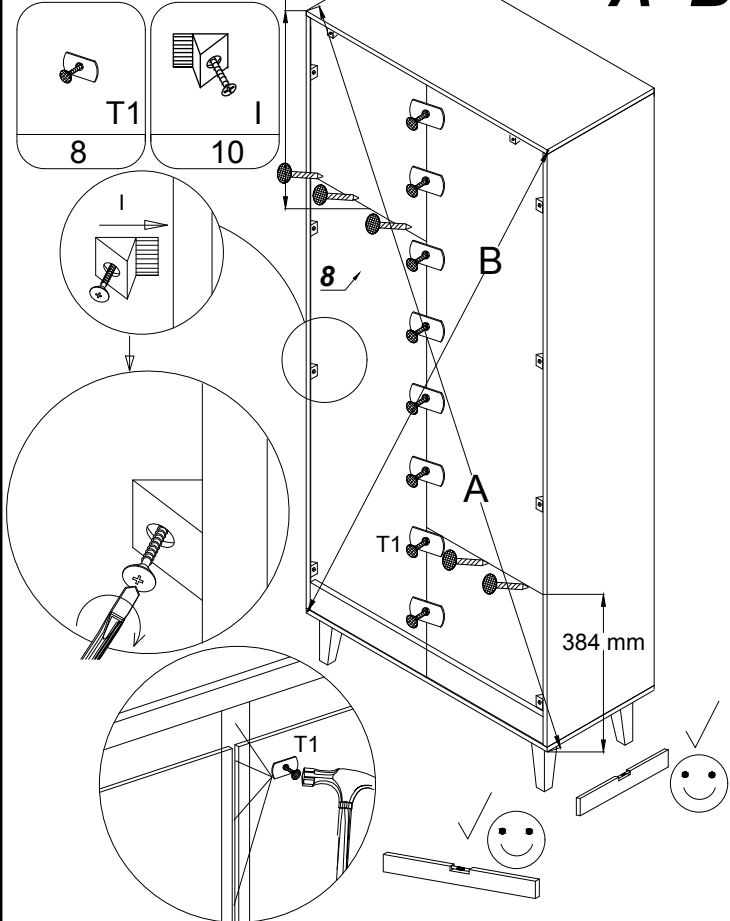

14

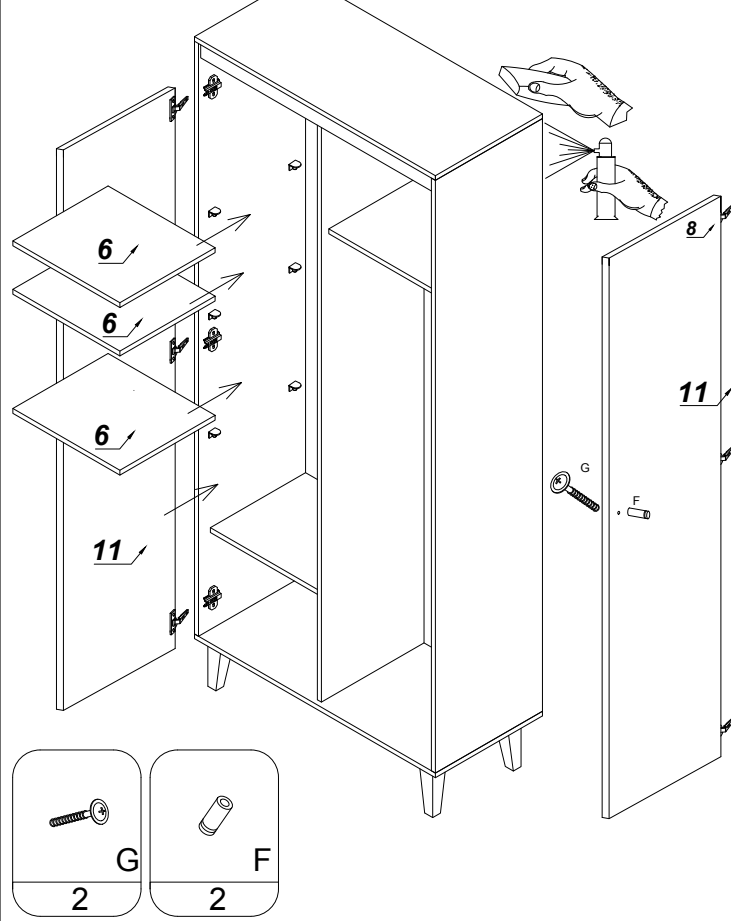

OPCJA 2

