

60 min

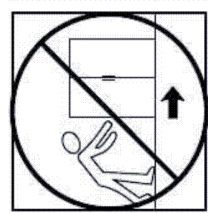

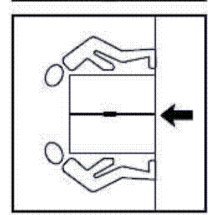

N01

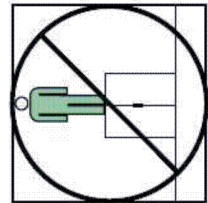
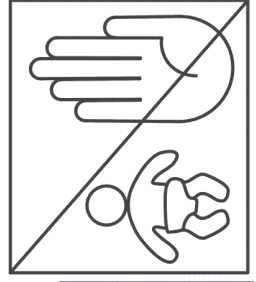
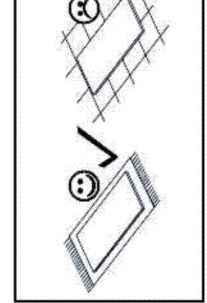
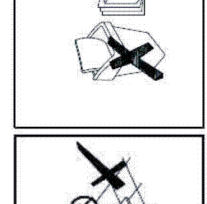
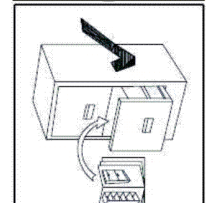
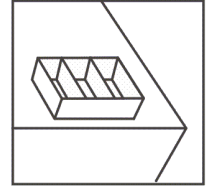
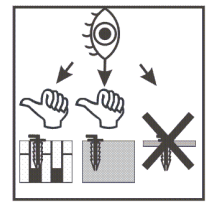
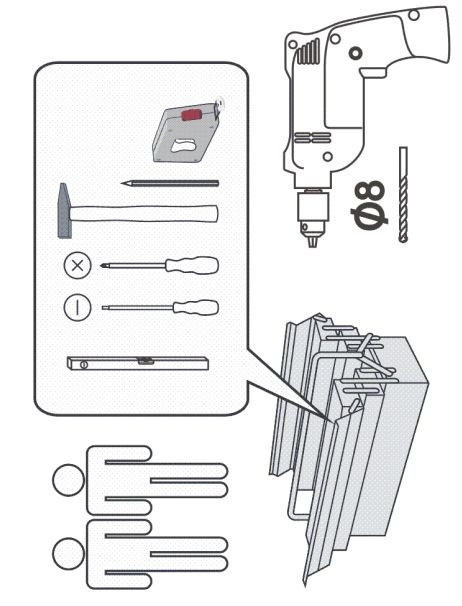
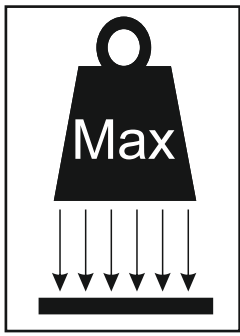
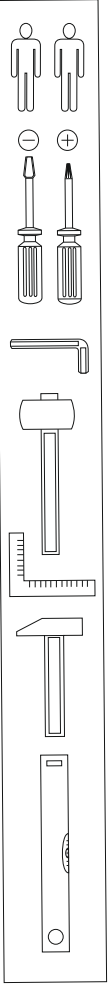

N02

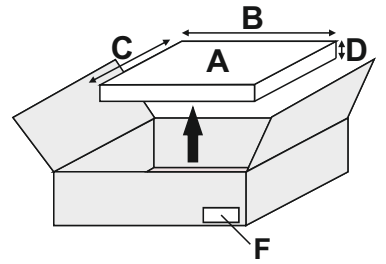

A	B (mm)	C (mm)	D (mm)	E	F
N01	1400	195	16	1	1 1
N02	1400	195	16	1	1 1

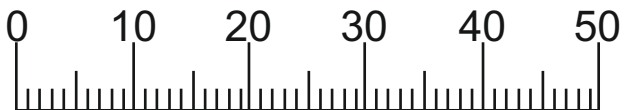
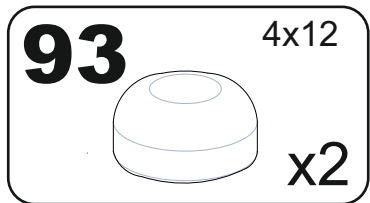
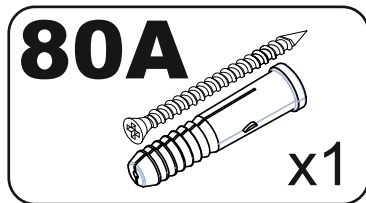
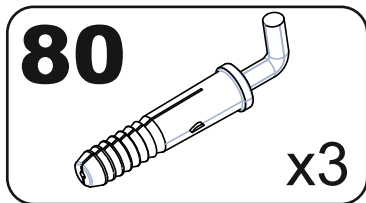
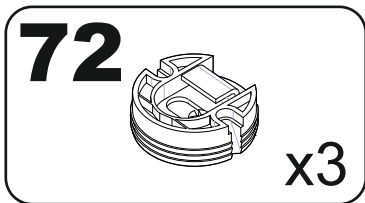
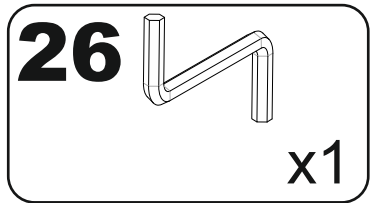
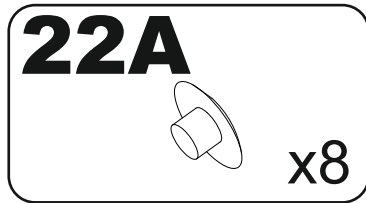
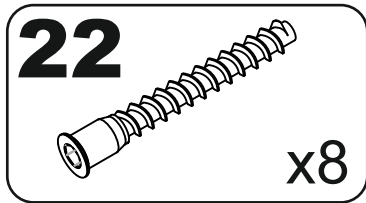
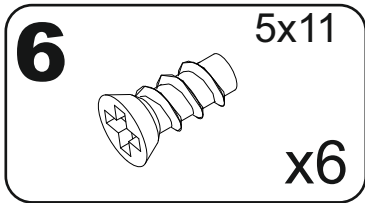

# I

**6** 5x11  
x6

**22**  
x8

**22A**  
x8

**72**  
x3

**80A**  
x1

**93** 4x12  
x2

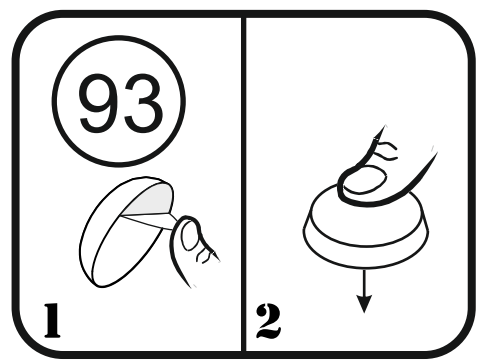
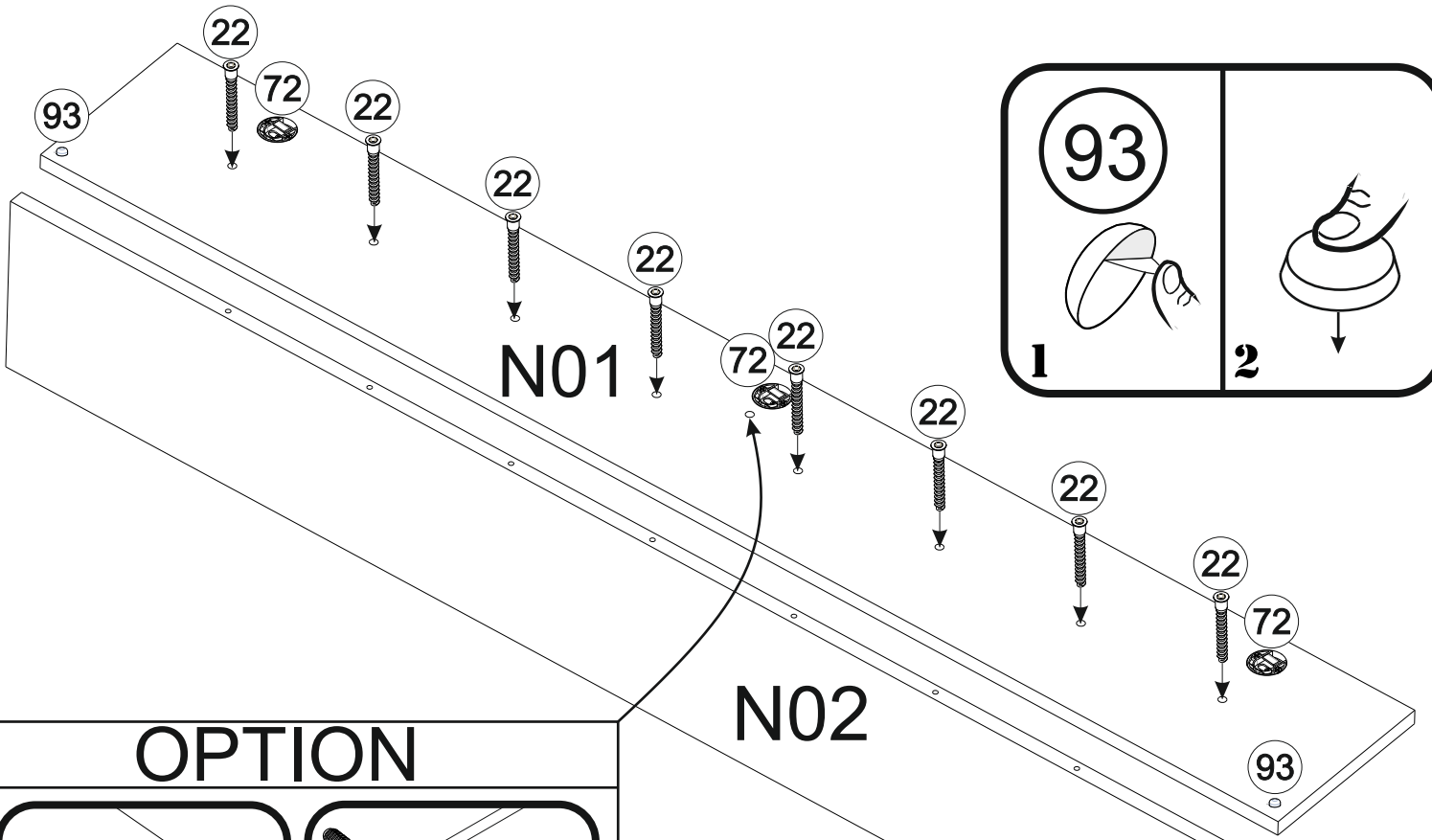
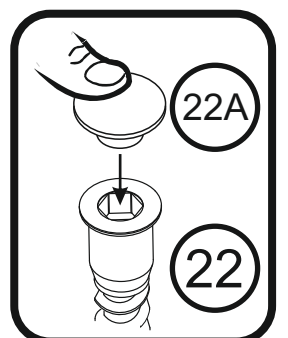
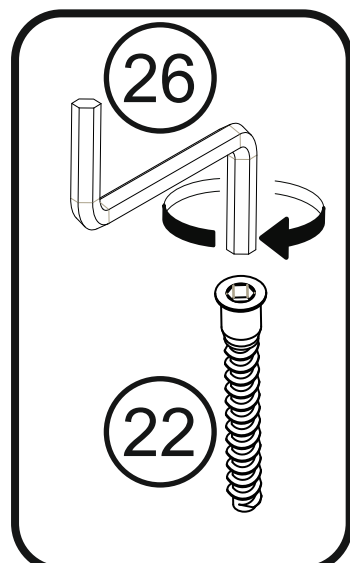
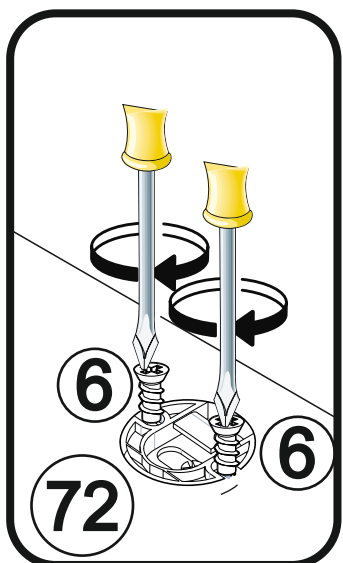
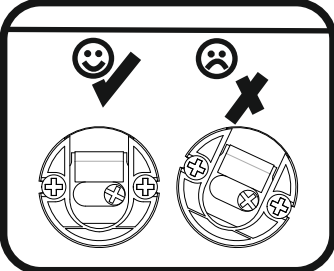
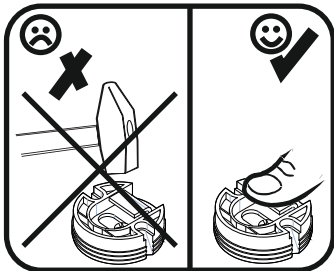

## OPTION

