

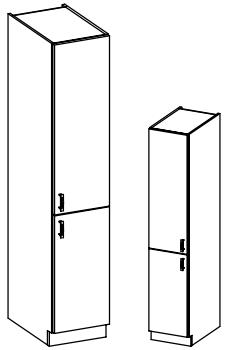











SARA

40 DK-2100 2F

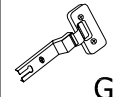
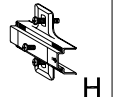

 B 12	 E1 12	 A 12	 O 1	 S24 2	4.0x30mm  R2 4	3.0x20mm  P7 10-15
 J 16	 G 5	 H 5	3.5x13mm  P5 12	 F2 4		
4.0x45mm  P4 2	 E9 2	 L19 1				

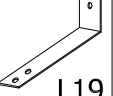
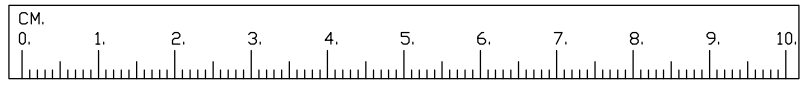
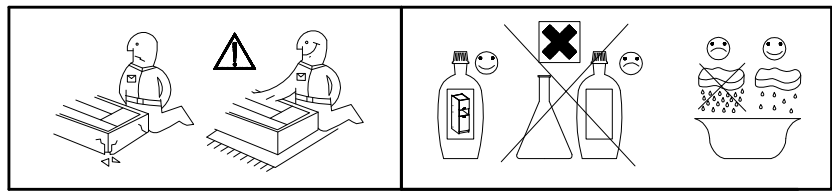
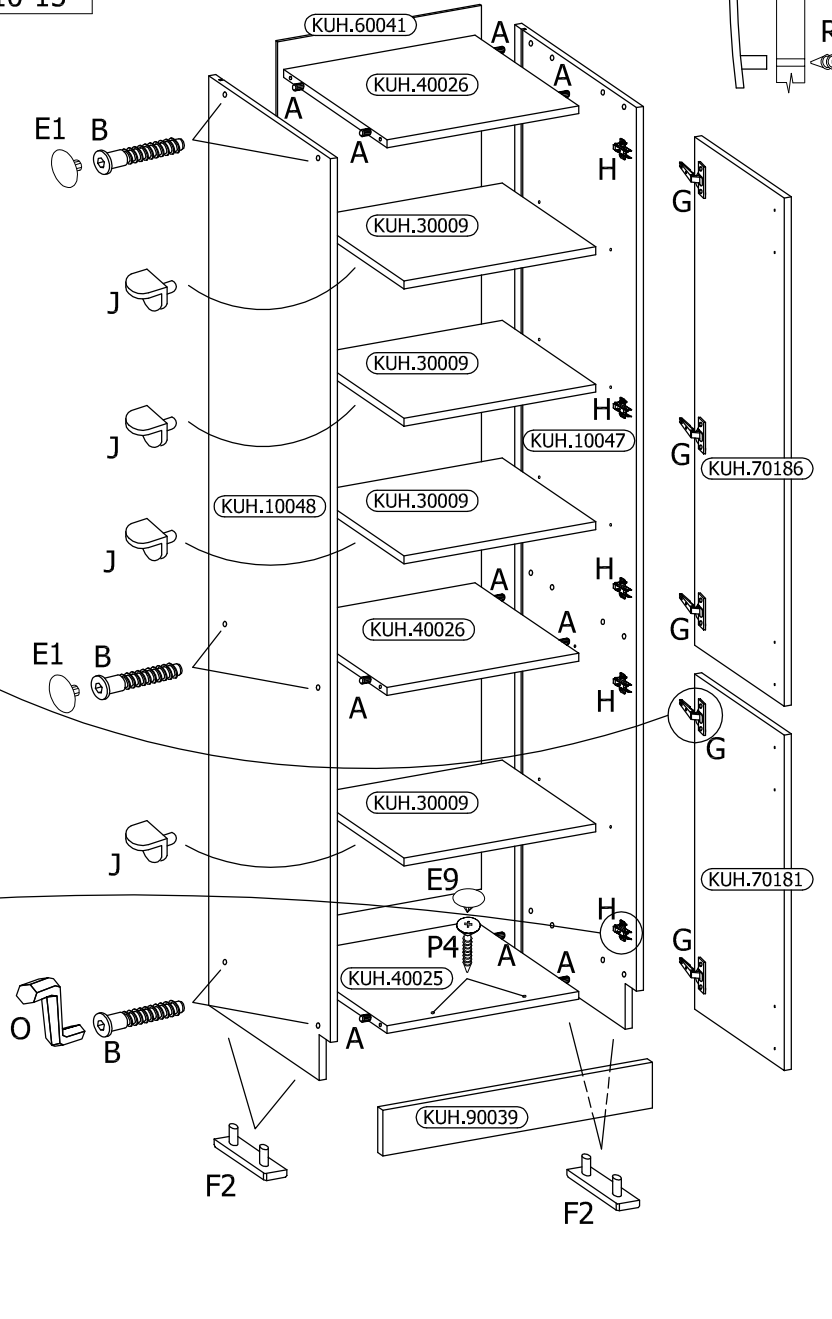
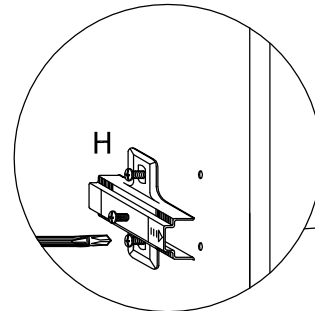
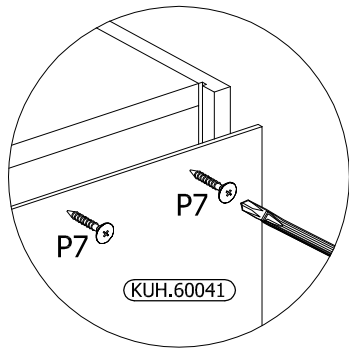
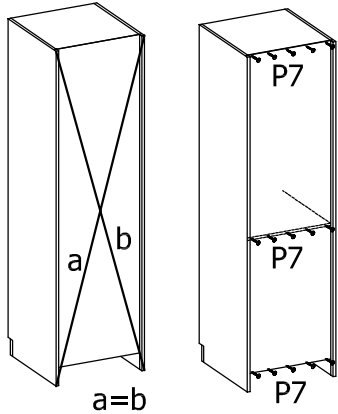
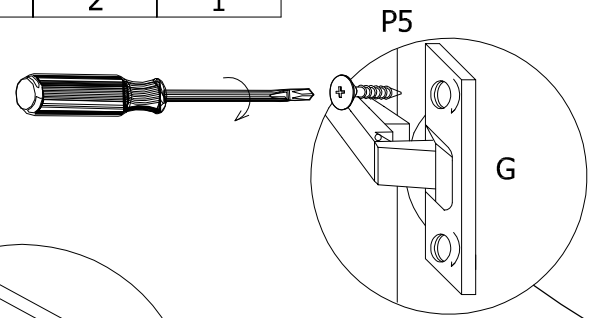
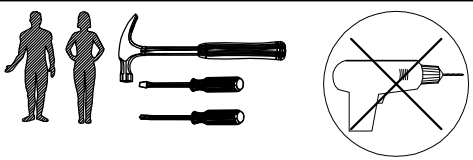
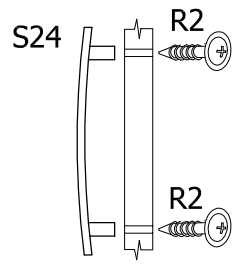

ISM-KUH-00144

SARA

40 DK-2100 2F

