

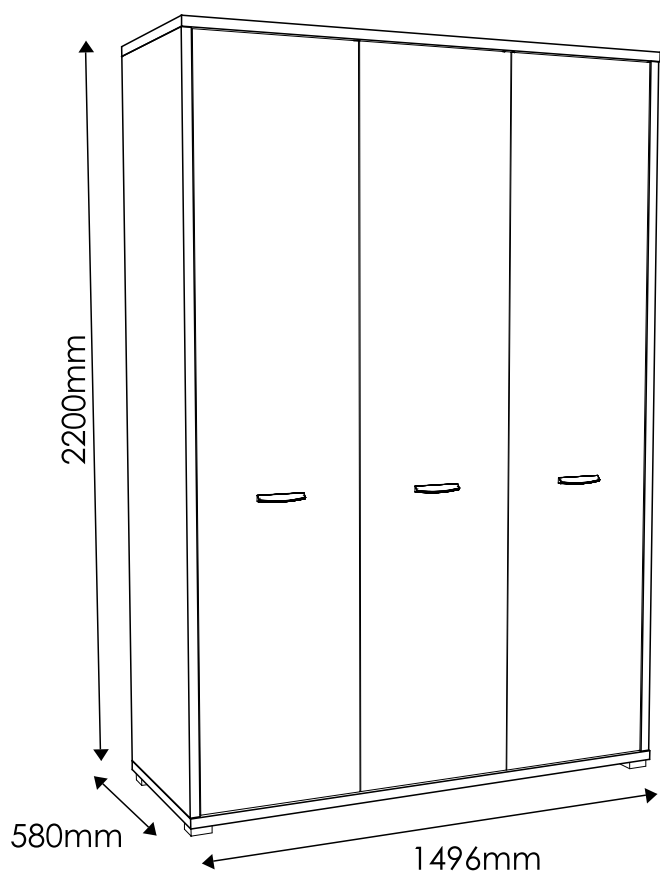

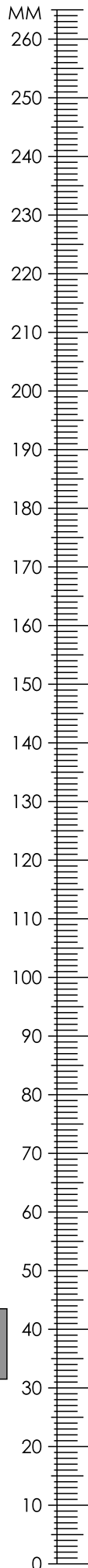







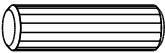
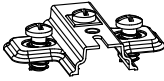



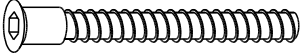
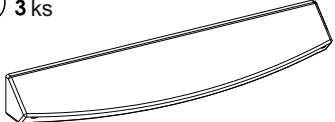

CLARO

TYP 22 - SKRIŇA 3D

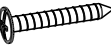
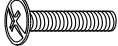
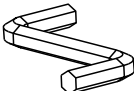

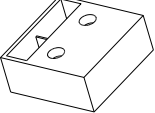
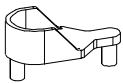

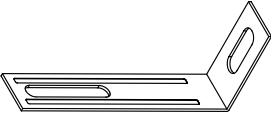
Kovanie

A1 26 ks $\varnothing 8 \times 35\text{mm}$ 	B0 9 ks 	B2 3 ks 
B3 6 ks 	C1 18 ks EURO 4 x 13mm 	D2 24 ks 
E0 12 ks (do E1) 	E1 12 ks $\varnothing 15 \times 12\text{mm}$ 	F1 12 ks $\varnothing 6 \times 34\text{mm}$ 
G0 6 ks (do G1 i G2) 	G2 6 ks Konfirmat $\varnothing 7 \times 60\text{mm}$ 	H1 3 ks 
I2 2 ks UP 4 x 16mm 	I11 10 ks UP 4 x 30mm 	K3 6 ks M4 x 22mm 
M 1 ks 	N1 80 ks US 3 x 16mm 	O10 2 ks $\varnothing 50 \times 25\text{mm}$ 
O13 4 ks 60 x 60 x 25mm 	P4 4 ks 	P0 6 ks $\varnothing 5$ 
Q9 2 ks 	R1 10 ks 	Z1 2 ks (L-942) 

POZOR !!!
Kovanie držte mimo dosahu detí!

Potrebné náradie

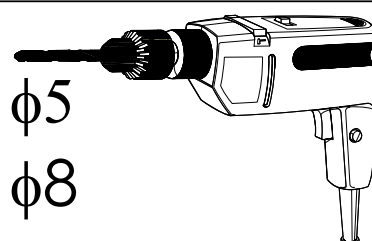
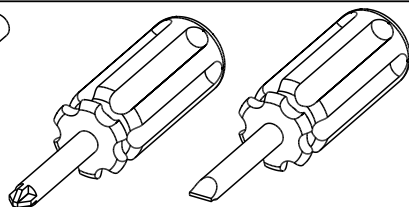
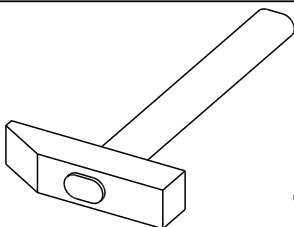

1 Bok ľavý

1 ks

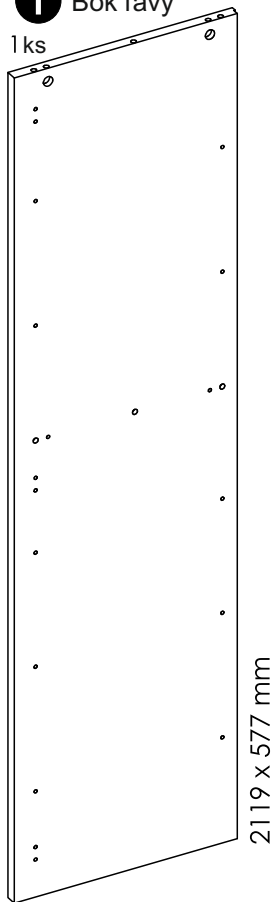

2119 x 577 mm

2 Priečka vertikálna

1 ks

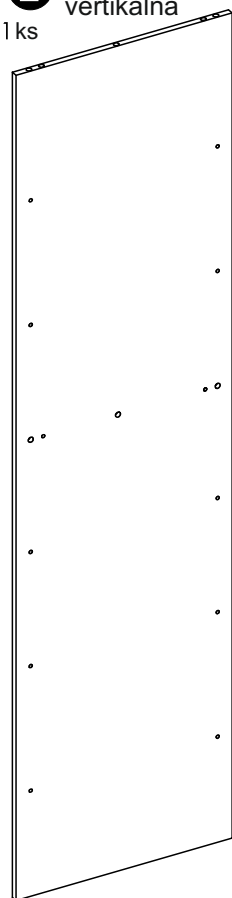

2119 x 555 mm

3 Bok pravý

1 ks

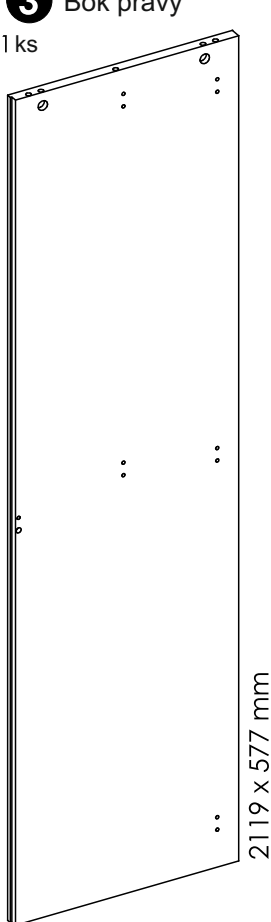

2119 x 577 mm

9 Dvere

3 ks

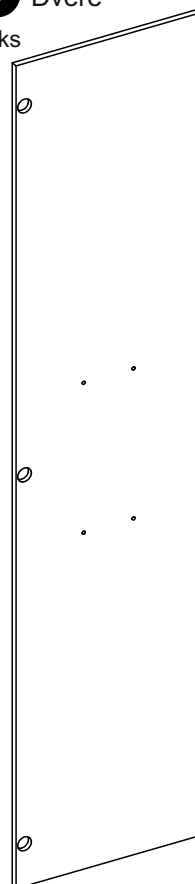

2113 x 476 mm

4 Horná doska

1 ks

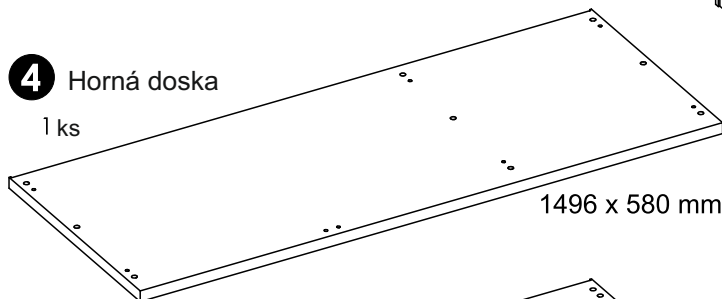

1496 x 580 mm

5 Dolná doska

1 ks

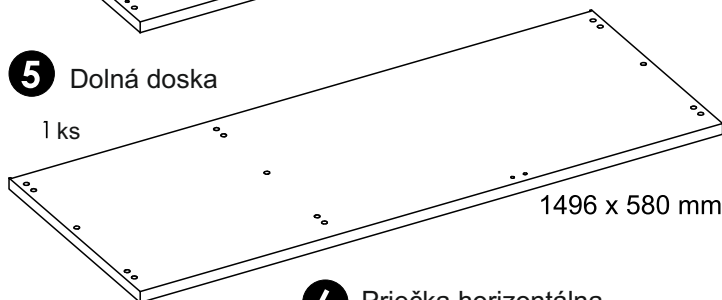

1496 x 580 mm

6 Priečka horizontálna

1 ks

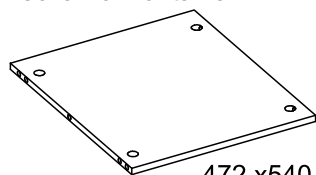

472 x 540 mm

7 Lišta

1 ks

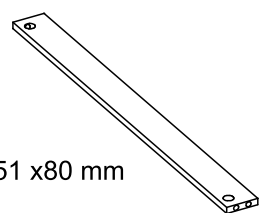

951 x 80 mm

8 Polica

5 ks

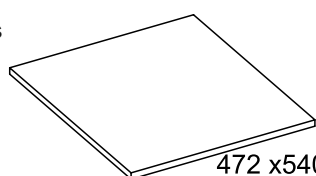

472 x 540 mm

10 Zadná stena

1 ks

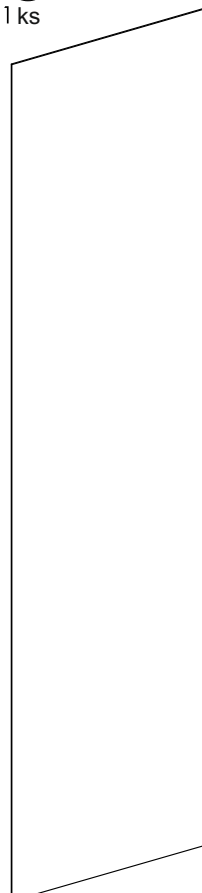

2148 x 495 mm

11 Zadná stena

1 ks

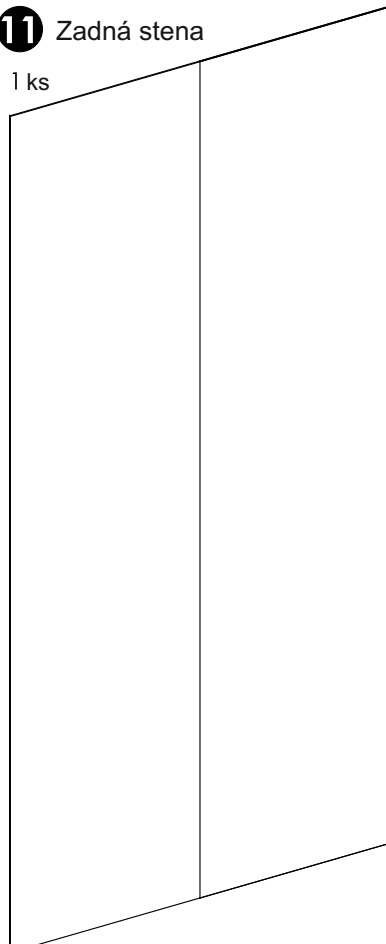

2148 x 972 mm

Krok 1:

Krok 2:

Krok 3:

Krok 4:



Schéma skladania



2 ▶

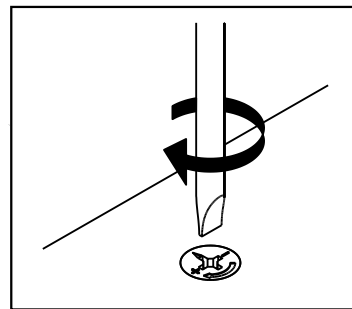
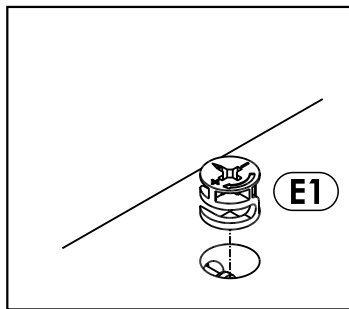
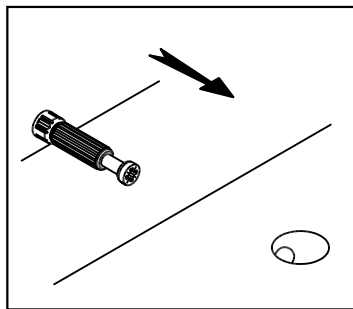
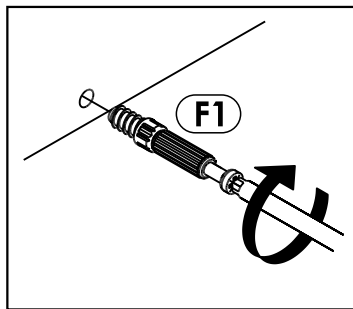
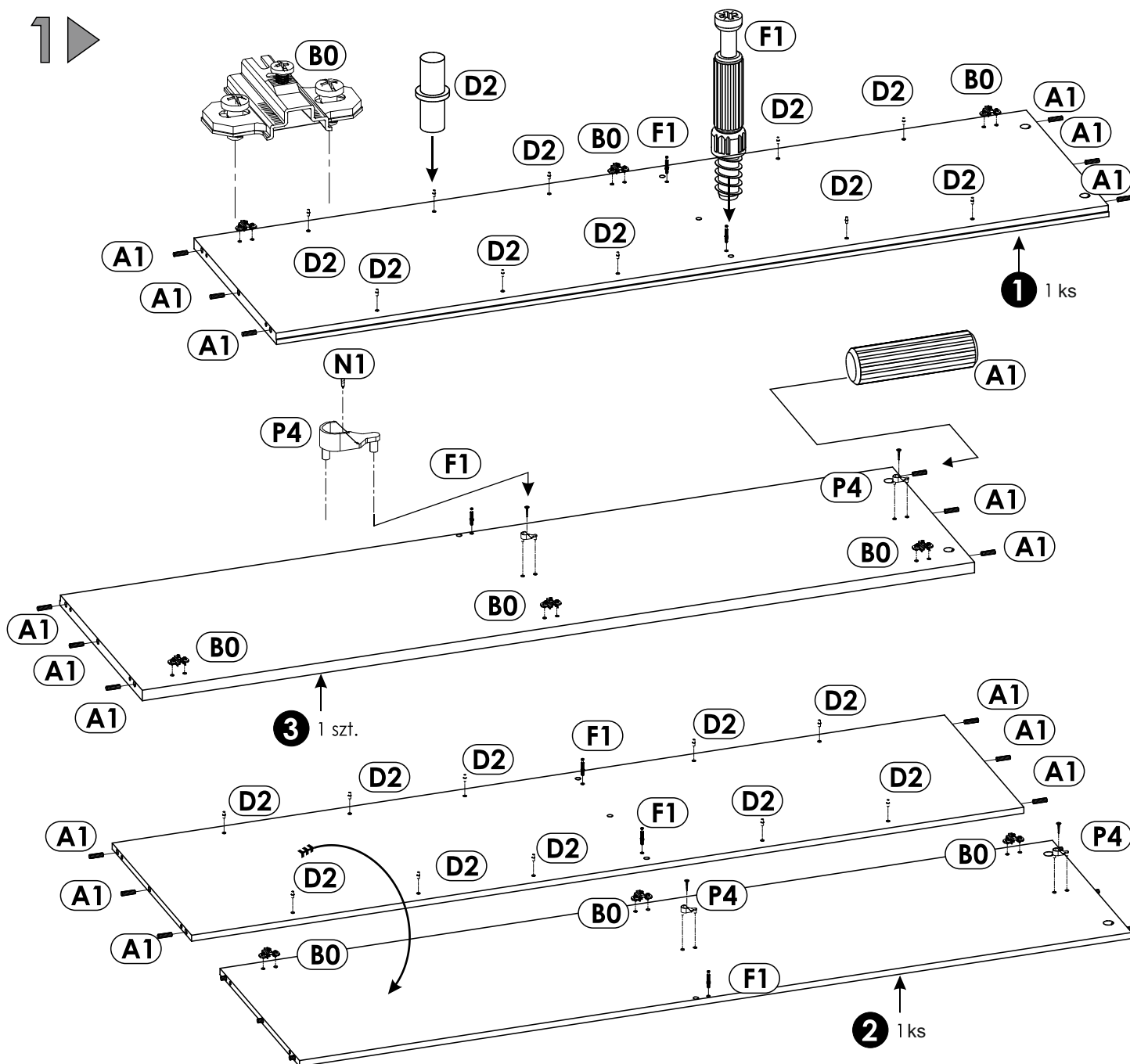
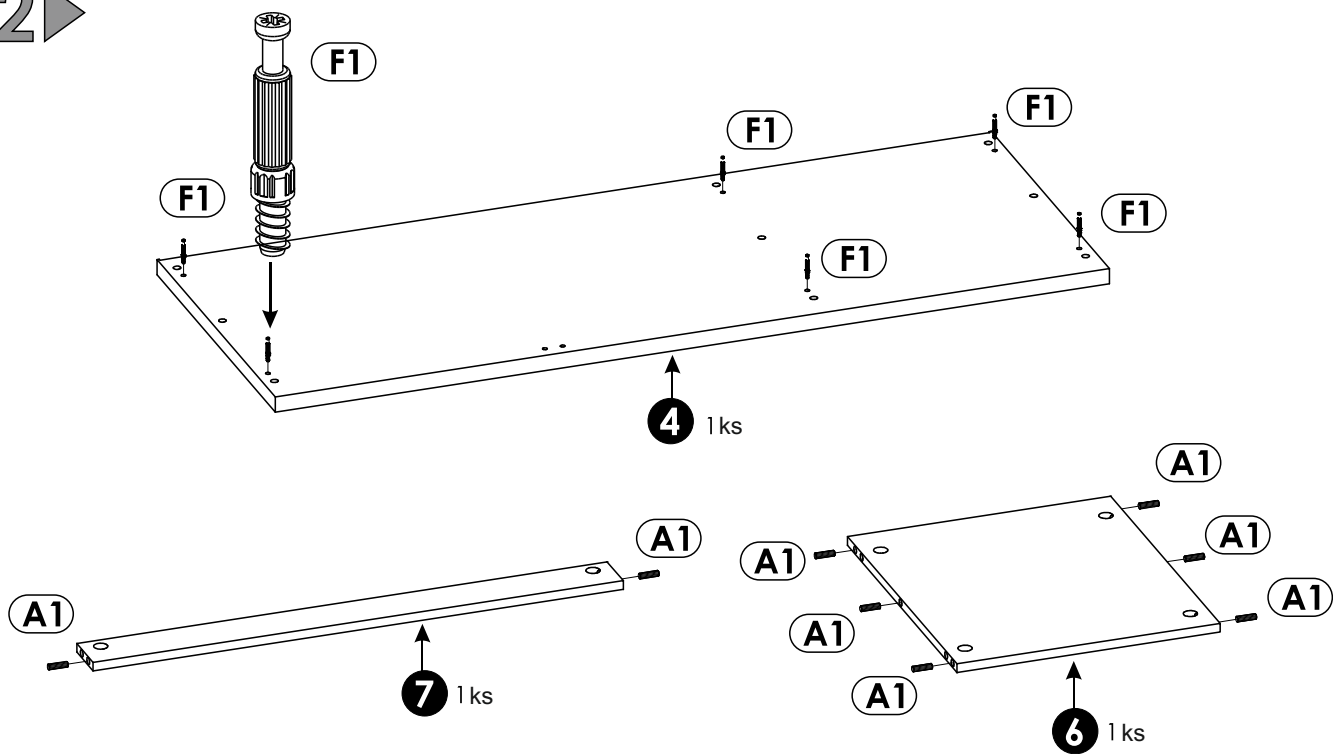

3 ▶

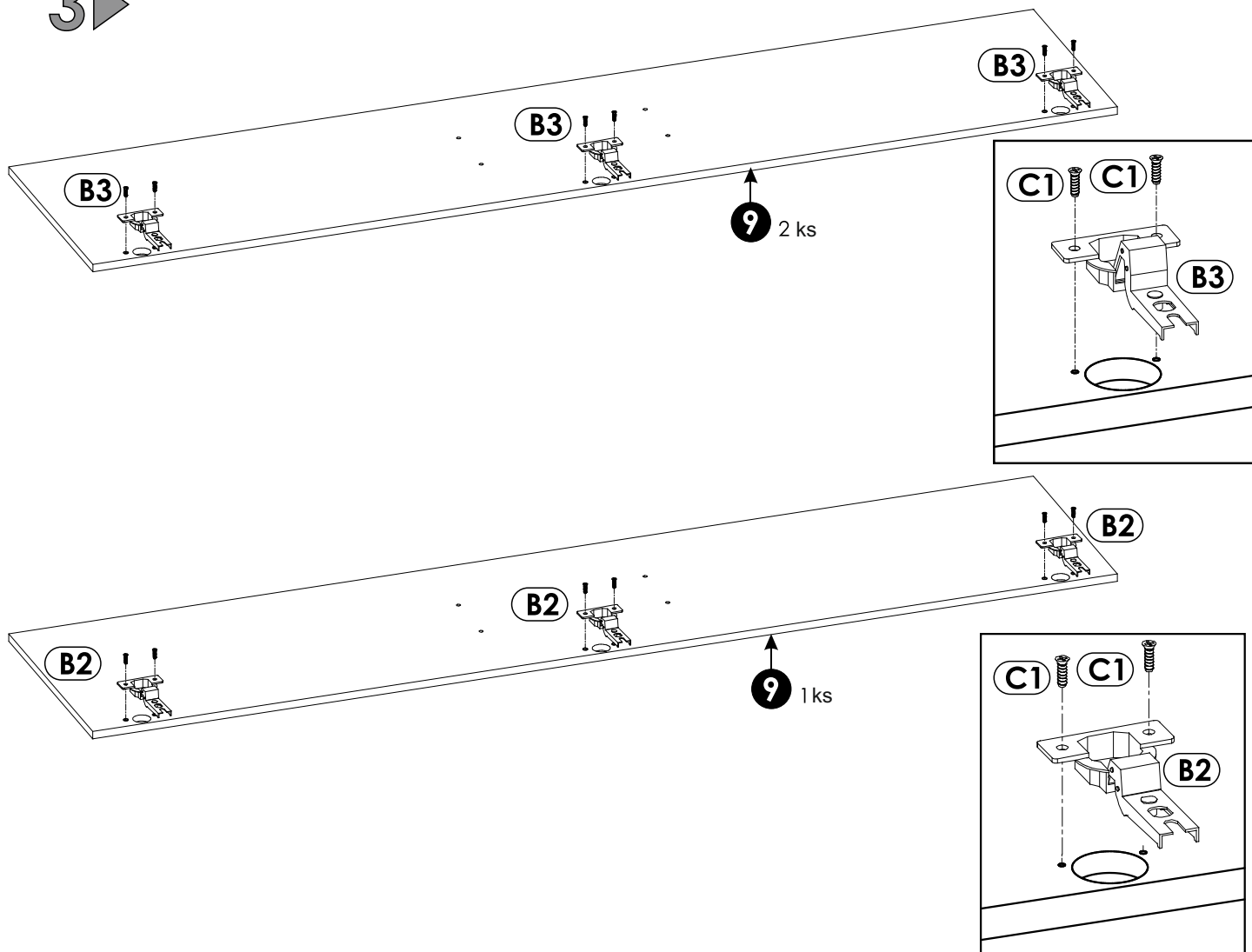

4 ▶

POZOR !!!
Zásada montáže na str. 4.

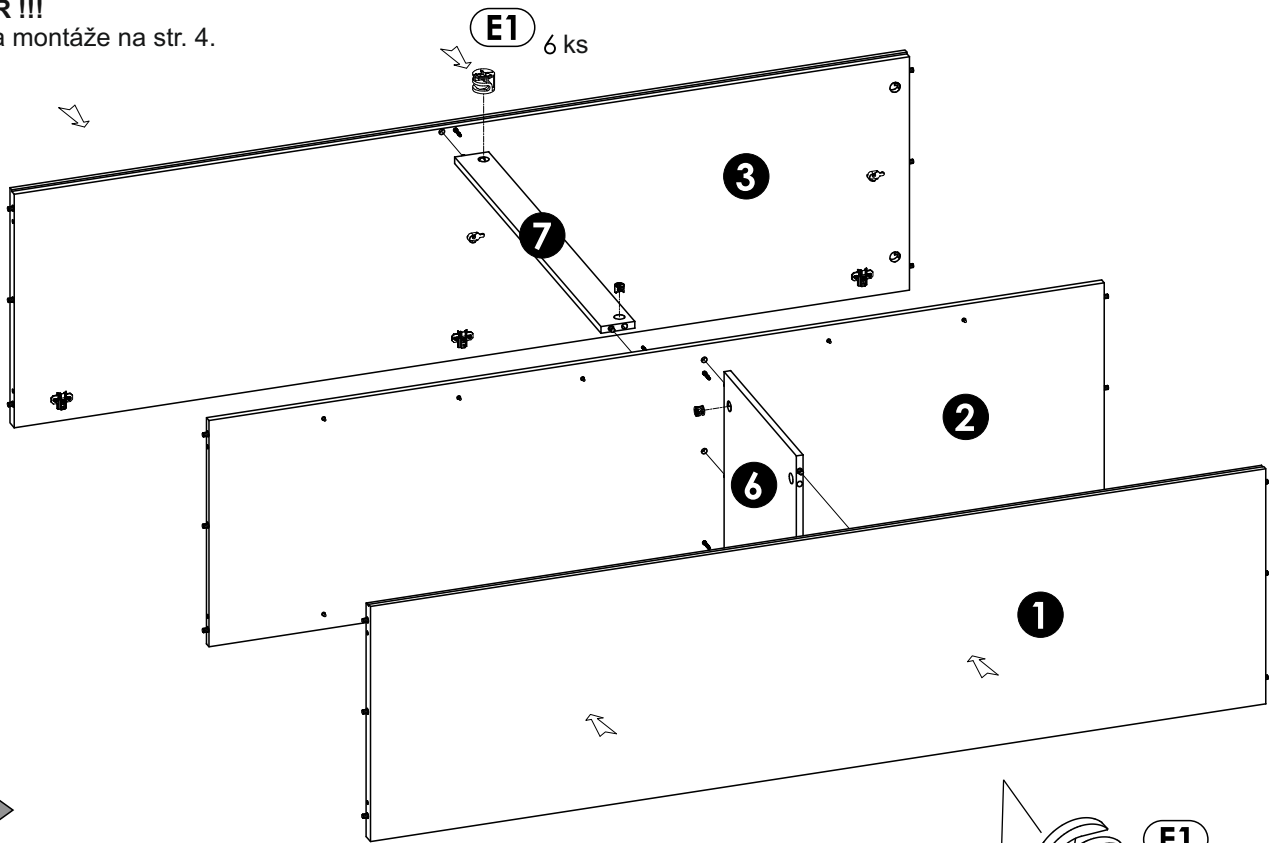

5 ▶

POZOR !!!
Zásada montáže na str. 4.

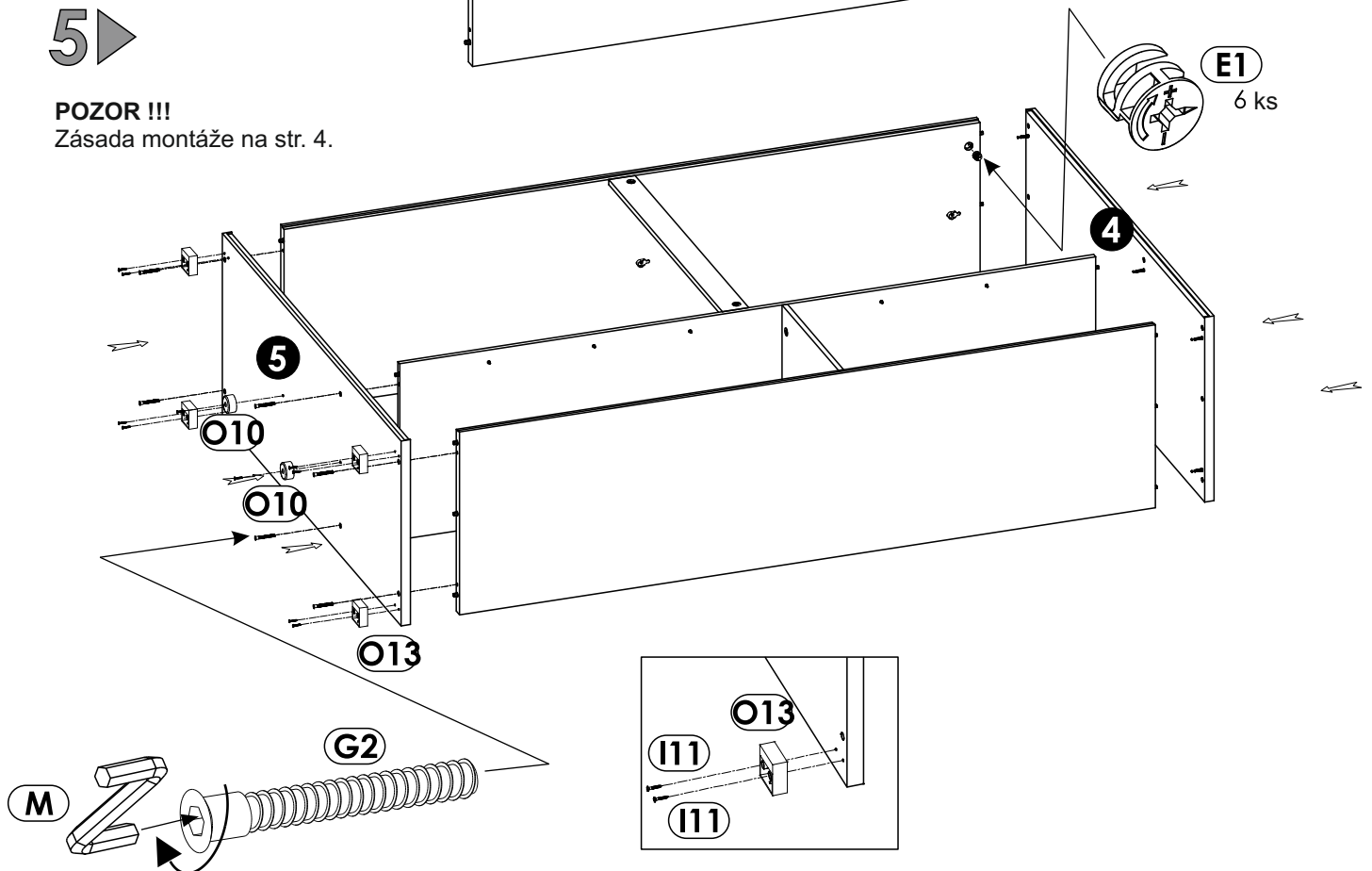

6 ▶

POZOR !!!

Pred založením zadnej steny dbajte, aby uhlopriečky boli rovnako dlhé.
A=B

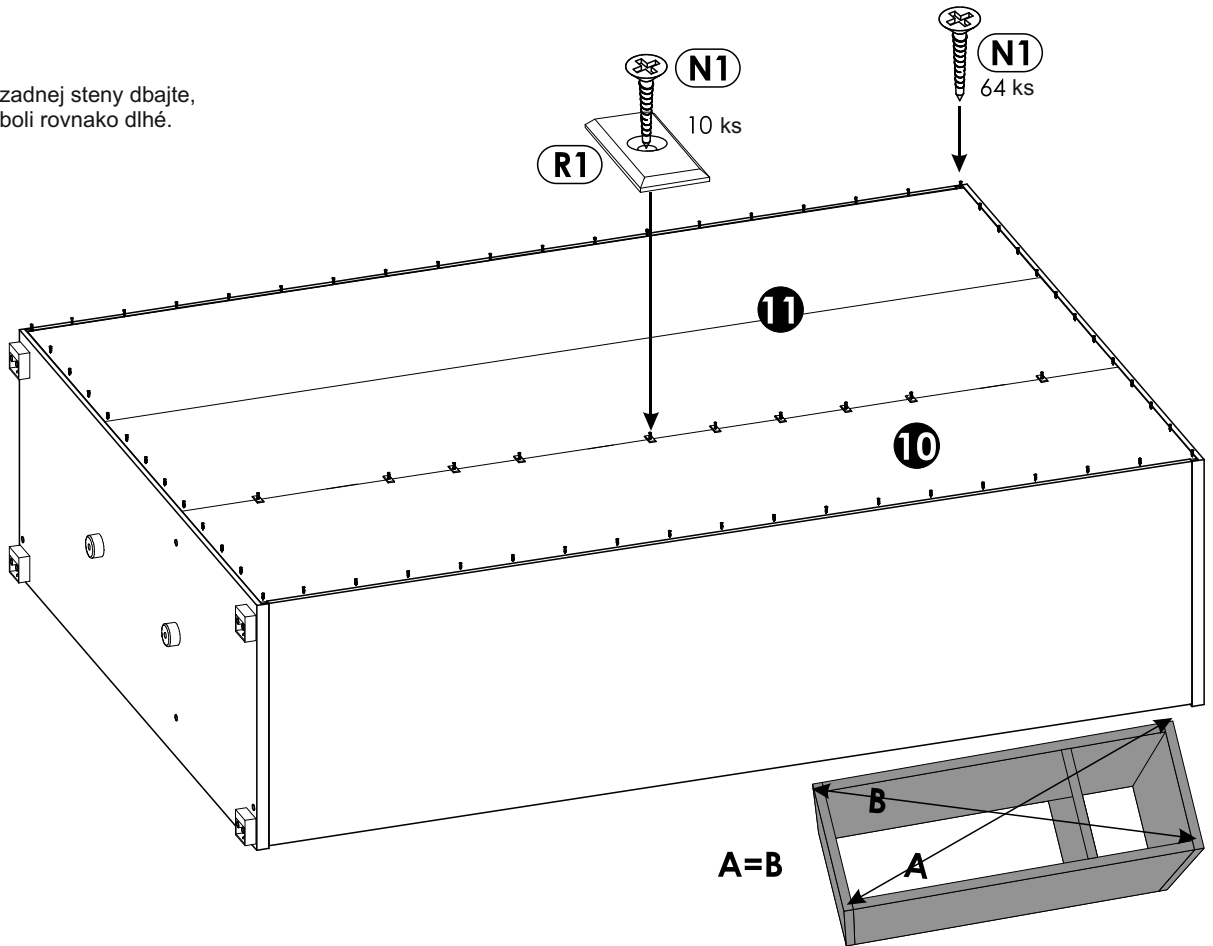

7 ▶

Výrobca odporúča skriňu pripevniť o stenu za pomoci kovania Q9.

Súčasťou výrobku nie sú skrutky a zmoždinky.

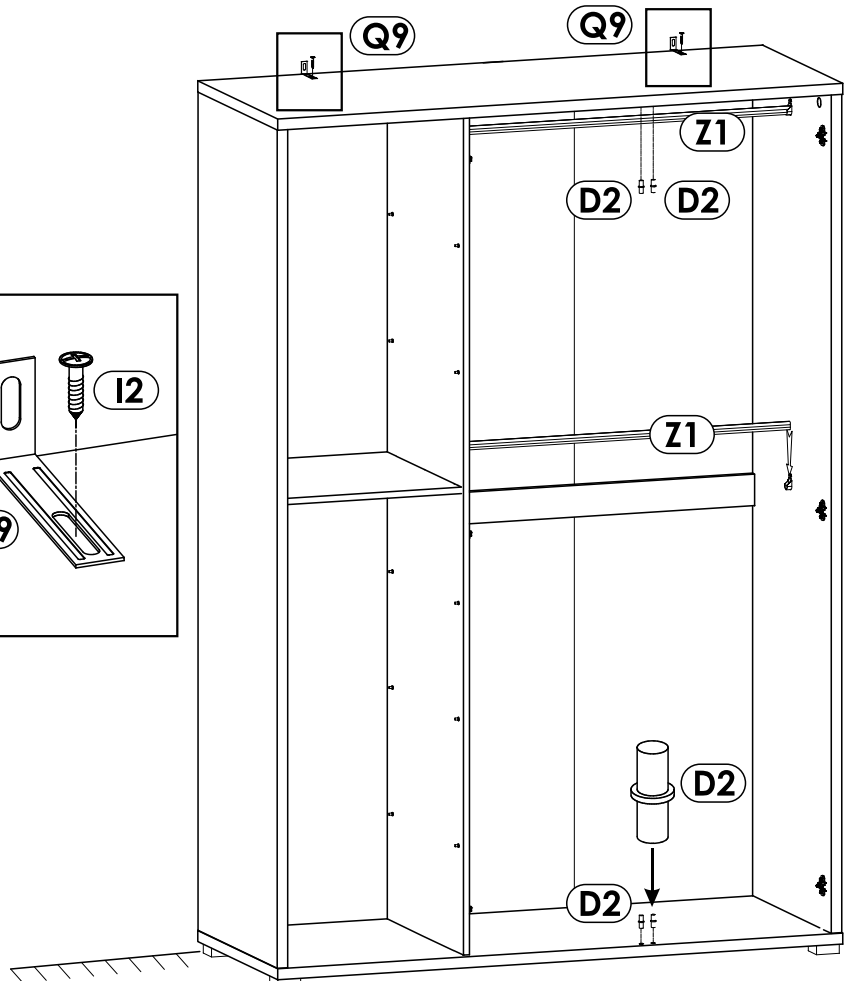
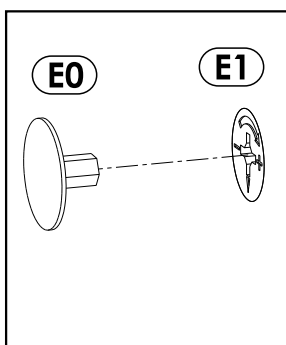
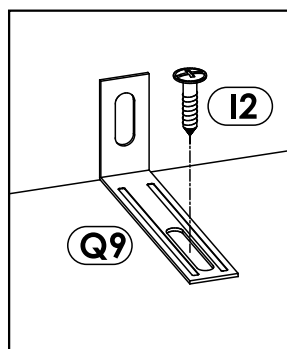

8 ▶

Založenie dverí.

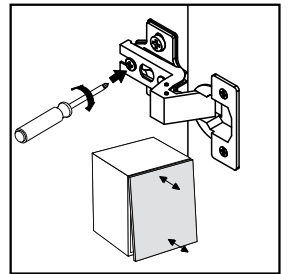
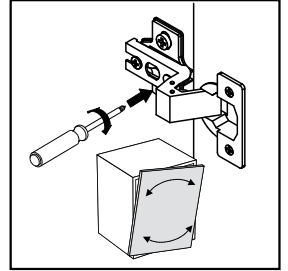
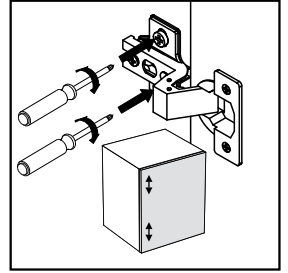
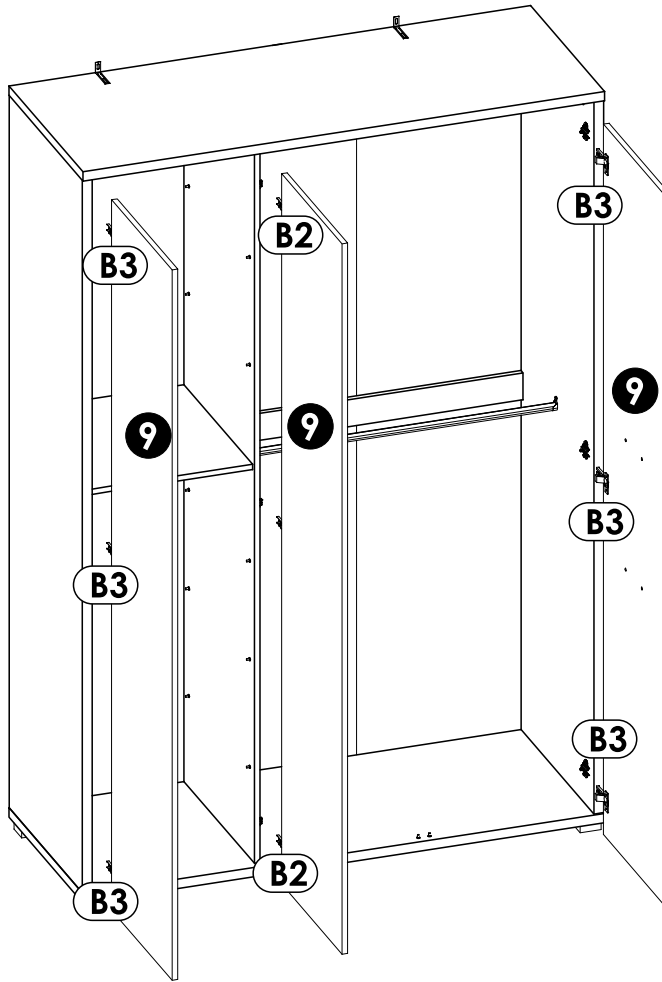
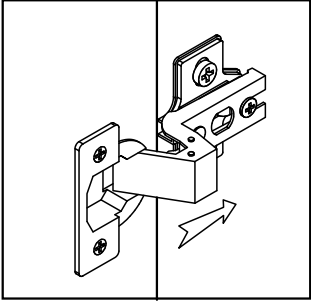

9 ▶

Na prikrútenie úchytovej lišty je potrebné prevrátiť otvory z vnútornej strany dverí.

Slepé otvory vyplňte záslepkou P0.

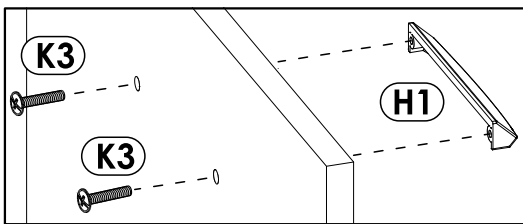

MAX 5kg

